

**Westwood** electrodes & insulators  
 HIGH DIELECTRIC STRENGTH • PRECISION DIMENSIONS

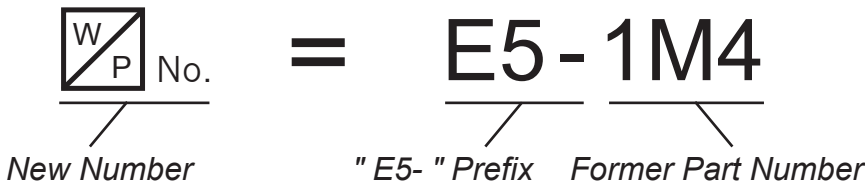

**NOTE: Electrode and related items part numbers are now "E5-" followed by the former number.**

Example:



**Type 1M**

Insulator length	W/P No.
4"	E5-1M4
4-1/4"	E5-1M4-1/4
4-1/2"	E5-1M4-1/2
5"	E5-1M5
6"	E5-1M6
7"	E5-1M7
8"	E5-1M8

**Type 2M**

Insulator length	W/P No.
4"	E5-2M4
4-1/2"	E5-2M4-1/2
5"	E5-2M5
5-1/2"	E5-2M5-1/2
6"	E5-2M6
7"	E5-2M7
8"	E5-2M8

**Type 3M**

Insulator length	W/P No.
4"	E5-3M4
4-1/2"	E5-3M4-1/2
5"	E5-3M5
5-1/2"	E5-3M5-1/2
6"	E5-3M6
7"	E5-3M7
8"	E5-3M8

**Type 4M**

Insulator length	W/P No.
4"	E5-4M4
4-1/4"	E5-4M4-1/4
4-1/2"	E5-4M4-1/2
5"	E5-4M5
6"	E5-4M6
7"	E5-4M7
8"	E5-4M8

**Type 5M**

Insulator length	W/P No.
4"	E5-5M4
5"	E5-5M5
6"	E5-5M6

**Type 2F**

Insulator length	W/P No.
4"	E5-2F4
4-1/2"	E5-2F4-1/2
5"	E5-2F5
5-1/2"	E5-2F5-1/2
6"	E5-2F6
7"	E5-2F7
8"	E5-2F8

**Type 3F**

Insulator length	W/P No.
4"	E5-3F4
4-1/2"	E5-3F4-1/2
5"	E5-3F5
5-1/2"	E5-3F5-1/2
6"	E5-3F6
7"	E5-3F7
8"	E5-3F8

Note: To order the insulator only for any electrode found on this page, add "INS" to the part number.

**Westwood** electrodes & insulators

HIGH DIELECTRIC STRENGTH • PRECISION DIMENSIONS

<p>Ace "A" E5-100 Ace 5" E5-100B Ace 6" E5-100C Ace 7"</p>	<p>Arco E5-124</p> <p>Arco E5-126</p>	<p>ABC 6" E5-144A ABC 5" E5-144B ABC 4-1/2" E5-144C ABC 4" E5-144D ABC 3" E5-144E ABC 2" E5-144F ABC 1-3/4" E5-144G ABC None E5-144H</p>
<p>Ace E5-100A</p>	<p>Arco E5-127</p>	<p>ABC E5-146</p>
<p>Acme E5-102A</p>	<p>Arco E5-127A</p>	<p>ABC 4" E5-146A ABC none E5-146B ABC 4-1/2" E5-146C</p>
<p>Acme E5-102B</p>	<p>Armstrong E5-128</p>	
<p>Acme E5-107</p>	<p>ABC (with bracket) E5-130</p>	<p>ABC E5-147</p>
<p>Aeroil E5-108</p>		<p>ABC E5-148</p>
<p>Aero E5-109</p>	<p>ABC (with bracket) E5-130A</p>	<p>ABC E5-148A</p>
<p>Aero E5-110</p>		<p>ABC E5-148B</p>
<p>Aero E5-110B</p>	<p>ABC "A" E5-131A ABC 4" E5-132A ABC 5"</p>	<p>ABC E5-148C</p>
<p>Alcoa E5-111</p>		<p>ABC spring E5-148D</p>
<p>Aero "A" E5-111A Aero none E5-111D Aero 9-1/2" E5-111E Aero 13-1/2" E5-111F Aero 4-3/4" E5-111G Aero 7-1/2"</p>	<p>ABC "A" E5-131 ABC 4" E5-132 ABC 5"</p>	<p>ABC spring E5-148E</p>
<p>Arco E5-121</p>	<p>ABC L R E5-133</p>	<p>ABC E5-148F</p>
<p>Arco E5-122</p>	<p>ABC A E5-137B ABC 4" E5-137C ABC 5" E5-137E</p>	<p>ABC spring E5-148H</p>
<p>Arco E5-123</p>		<p>ABC spring E5-148J</p>
		<p>ABC ← with 6" spring E5-148K</p>

Please order by No.

**Westwood** electrodes & insulators

HIGH DIELECTRIC STRENGTH • PRECISION DIMENSIONS

<p>ABC E5-148M</p>	<p>Beckett E5-151L</p>	<p>Beckett AF II HLX E5-151Z</p>
<p>ABC Sunray OE-1 E5-148Q</p>	<p>Beckett E5-151M</p>	<p>Beckett AF 15 E5-152B</p>
<p>ABC Sunray                      ABC Sunray                      ABC Sunray</p> <p>"A" "B" "C"                      7/16" 3-1/4" 3/4"                      7/16" 4-1/4" 1/4"                      15/16" 3-1/4" 3/4"</p> <p>E5-148R                      E5-148R1                      E5-148S</p>	<p>Beckett E5-151N</p>	<p>Beckett AF II FBX E5-152C</p>
<p>Beckett E5-151A</p>	<p>Beckett E5-151O</p>	<p>Bethlehem E5-156</p>
<p>Beckett E5-151B</p>	<p>Beckett E5-151P                      Beckett E5-151P1                      Beckett E5-151P2</p>	<p>Bettendorf E5-157</p>
<p>Beckett E5-151C</p>	<p>Beckett E5-151Q                      Beckett (without spring) E5-151Q1</p>	<p>Bettendorf E5-160</p>
<p>Beckett E5-151D</p>	<p>Beckett E5-151R                      Beckett E5-151R-1                      Beckett E5-151R-2                      Beckett E5-151R-3                      Beckett E5-151R-4</p>	<p>Bettendorf E5-160A</p>
<p>Beckett E5-151E</p>	<p>Beckett E5-151S                      Beckett E5-151T</p>	<p>Bettendorf E5-160B</p>
<p>Beckett E5-151E1</p>	<p>Beckett E5-151U</p>	<p>Bettendorf E5-160C</p>
<p>Beckett E5-151F</p>	<p>Beckett E5-151V</p>	<p>Bettendorf E5-160D</p>
<p>Beckett E5-151G</p>	<p>Beckett E5-151I</p>	<p>Bettendorf E5-160E</p>
<p>Beckett E5-151H</p>	<p>Beckett E5-151J</p>	<p>Bettendorf E5-160G</p>
<p>Beckett E5-151I1</p>	<p>Beckett E5-151K</p>	<p>Blueray E5-1880</p>
<p>Beckett E5-151J1</p>	<p>Beckett E5-151X</p>	<p>Bock E5-161B</p>
<p>Beckett E5-151K1</p>	<p>Bock E5-161C</p>	<p>Bock E5-161C1</p>

**Westwood** electrodes & insulators

HIGH DIELECTRIC STRENGTH • PRECISION DIMENSIONS

 Branford E5-170	 Carlin E5-188D	 Carlin E5-188P
 Carlin E5-184	 Carlin E5-188E	 Carlin E5-188Q
 "A" 9/16" Carlin 4" E5-184A Carlin 5" E5-184B Carlin 6" E5-184C	 Carlin E5-188F	 "B" 3-1/4" A 7/16" Carlin 7/8" 12" E5-188R2 Carlin 1-9/16" 12" E5-188R3 Carlin 7/8" 15" E5-188R4
 Carlin E5-185	 Carlin E5-188H	 Century E5-189
 Carlin E5-185A	 Carlin LH/RH E5-188I	 Century E5-190
 Carlin E5-186	 Carlin LH/RH E5-188J	 Century E5-191
 Carlin E5-187	 Carlin E5-188K	 Century E5-191A
 Carlin E5-187A	 Carlin E5-188L	 Century E5-191B
 "A" 9/16" Carlin 5" E5-187B Carlin 6" E5-187C	 Carlin E5-188M	 Chief E5-192
 Carlin E5-188	 Carlin 3-1/4" A 7/16" Carlin 7/8" E5-188N Carlin 1-9/16" E5-188N2	 Chief E5-192B
 Carlin E5-188A	 "A" 3-1/4" 7/16" Carlin 2-1/2" Heavy Tip E5-188N1 Carlin 11" E5-188N3 Carlin 1-1/2" E5-188N5 Carlin 8-1/2" E5-188N6 Carlin 4-1/2" E5-188N8 Carlin 6-1/2" E5-188N9	 Chrysler E5-193
 Carlin 3-1/4" A 7/16" Carlin 7/8" E5-188B Carlin 1-9/16" E5-188B2	 "A" 3-1/4" 7/16" Carlin 8-1/2" Light Tip E5-188N4 Carlin 4-1/2" E5-188N7 Carlin 6-1/2" E5-188N10	 Chrysler E5-195
 Carlin E5-188C	 Carlin E5-188O	 Clayton E5-198
		 Clayton E5-199
		 Clayton E5-199A

Please order by No.

**Westwood** electrodes & insulators

HIGH DIELECTRIC STRENGTH • PRECISION DIMENSIONS

<p>Clayton E5-199C</p>	<p>Cleaver Brooks</p>	<p>Columbia Boiler E5-207</p>												
<p>Clayton E5-199D</p>	<table border="0"> <tr> <td>E5-205F 21</td> <td>E5-205J 24</td> <td>E5-205O 12</td> </tr> <tr> <td>E5-205G 18-1/4</td> <td>E5-205K 27</td> <td>E5-205Q 30</td> </tr> <tr> <td>E5-205H 19-3/4</td> <td>E5-205L 14</td> <td></td> </tr> <tr> <td>E5-205I 15-3/4</td> <td>E5-205M 27-1/2</td> <td></td> </tr> </table>	E5-205F 21	E5-205J 24	E5-205O 12	E5-205G 18-1/4	E5-205K 27	E5-205Q 30	E5-205H 19-3/4	E5-205L 14		E5-205I 15-3/4	E5-205M 27-1/2		<p>Columbia Boiler E5-207A</p>
E5-205F 21	E5-205J 24	E5-205O 12												
E5-205G 18-1/4	E5-205K 27	E5-205Q 30												
E5-205H 19-3/4	E5-205L 14													
E5-205I 15-3/4	E5-205M 27-1/2													
<p>Cleanburn E5-199Z</p>	<p>Cleaver Brooks E5-205N</p>	<p>Columbia Boiler E5-207A</p>												
<p>Cleanburn E5-199Z1</p>	<p>Cleaver Brooks E5-205R</p>	<p>Crane Crane E5-213 "A" none E5-214 6"</p>												
<p>Cleaver Brooks E5-201</p>	<p>Cleaver Brooks E5-205T</p>	<p>Delco E5-220</p>												
<p>Cleaver Brooks E5-203</p>	<p>Cleaver Brooks E5-205U</p>	<p>Delco E5-221</p>												
<p>Cleaver Brooks E5-204A</p>	<p>Cleaver Brooks E5-205V</p>	<p>Delco E5-224</p>												
<p>Cleaver Brooks E5-205</p>	<p>Cleaver Brooks E5-205W</p>	<p>Delco E5-225</p>												
<p>Cleaver Brooks E5-205A Cleaver Brooks E5-205A5</p>	<p>Cleaver Brooks E5-205X</p>	<p>Delco E5-226</p>												
<p>Cleaver Brooks E5-205A1 Cleaver Brooks E5-205A2</p>	<p>Cleaver Brooks E5-205Y</p>	<p>Delco E5-227</p>												
<p>Cleaver Brooks E5-205A1 Cleaver Brooks E5-205A2</p>	<p>Cleaver Brooks E5-205Z</p>	<p>Delco E5-228</p>												
<p>Cleaver Brooks E5-205B</p>	<p>Cleaver Brooks E5-205Z1 Cleaver Brooks E5-205Z2</p>	<p>Delco E5-231</p>												
<p>Cleaver Brooks E5-205D Cleaver Brooks E5-205E Cleaver Brooks E5-205E2</p>	<p>Coleman E5-202A</p>	<p>Dravo E5-232</p>												
<p>Cleaver Brooks E5-205D Cleaver Brooks E5-205E Cleaver Brooks E5-205E2</p>	<p>Coleman E5-202B</p>	<p>Dravo E5-232A Dravo E5-232B</p>												
<p>Cleaver Brooks E5-205D Cleaver Brooks E5-205E Cleaver Brooks E5-205E2</p>	<p>Columbia Boiler E5-206</p>	<p>Dravo E5-232C</p>												

**E5**

**Westwood** electrodes & insulators









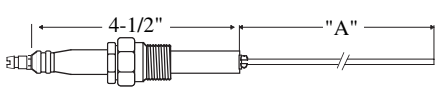
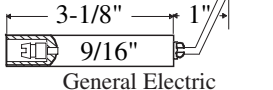
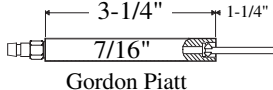
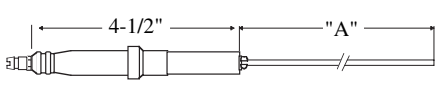
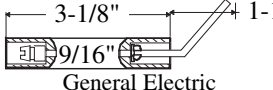
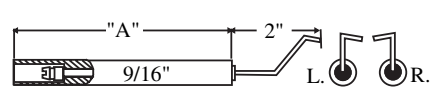
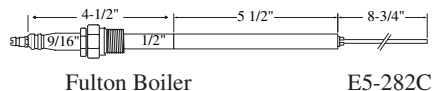
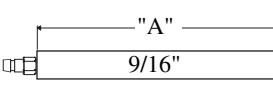
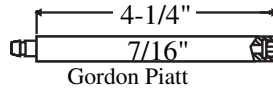
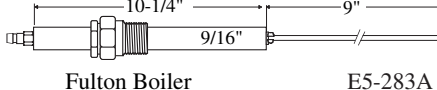

HIGH DIELECTRIC STRENGTH • PRECISION DIMENSIONS

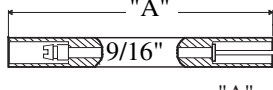
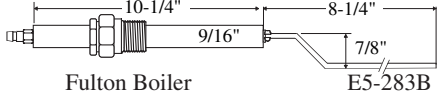
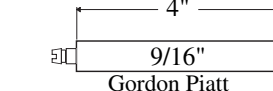
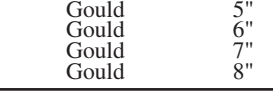
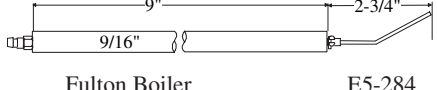
 Dravo E5-232D	 Ducane OilMaster™ E5-234L Ducane OilMaster™ E5-234M	 Electromagic E5-249A
 Dravo E5-232E		 Enterprise E5-253
 Dravo E5-232F	 Eclipse E5-235 Eclipse E5-235A Eclipse E5-235B	 Enterprise E5-253B Enterprise E5-253C Enterprise E5-253D
 Dravo E5-232G		
 Dravo E5-232H	 Eclipse E5-236	 Eroc E5-254
 Dravo E5-232I	 Eclipse E5-238	 Eroc E5-257
 Dravo E5-232J	 Eclipse E5-238B	 Esso E5-258
 Dravo E5-232L	 Economite E5-239	 Esso E5-259
 Dravo E5-232M	 Economite E5-239A	 Esso E5-259A
 Dravo E5-232N	 Economite E5-239B	 Esso E5-261
 Dravo E5-233	 Economite E5-239C	 Flame Guard E5-267A Flame Guard E5-267B Flame Guard E5-267C Flame Guard E5-267E Flame Guard E5-267F Flame Guard E5-267G
 Dravo E5-234	 Economite E5-239D	
 Ducane E5-234A Ducane E5-234B Ducane E5-234C Ducane E5-234D	 Economite E5-239E	 Flame Guard E5-267D
	 Economite E5-239F	 Fluid Heat E5-273
 Ducane E5-234E Ducane E5-234F Ducane E5-234G Ducane E5-234H Ducane E5-234I Ducane E5-234J	 Edison E5-246	 Fluid Heat E5-274
	 Edison E5-247	 Fluid Heat E5-275

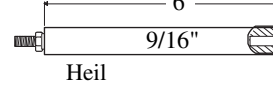
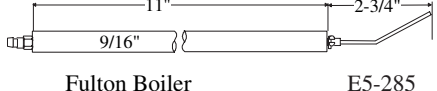
Please order by No.

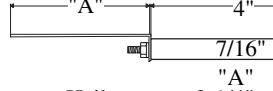
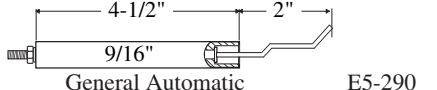
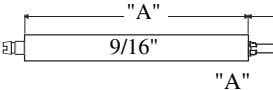
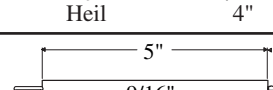
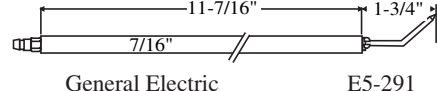
**Westwood** electrodes & insulators

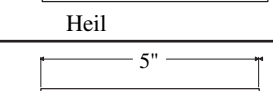
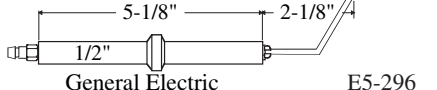
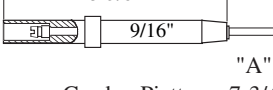
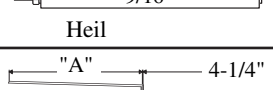
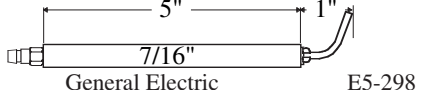
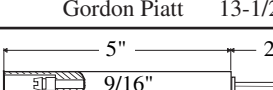
HIGH DIELECTRIC STRENGTH • PRECISION DIMENSIONS

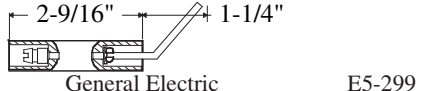
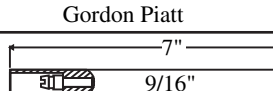
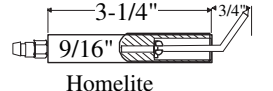
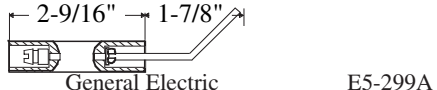
 <p>Fulton Boiler Fulton Boiler</p> <p>"A" 12-1/4" 17-1/4"</p> <p>E5-282 E5-283</p>	 <p>General Electric General Electric</p> <p>E5-301 E5-301A</p>	 <p>Gordon Piatt Gordon Piatt</p> <p>E5-307U E5-307V</p>
 <p>Fulton Boiler Fulton Boiler</p> <p>"A" 12-1/4" 17-1/4"</p> <p>E5-282A E5-282B</p>	 <p>General Electric General Machine</p> <p>E5-301B E5-303</p>	 <p>Gordon Piatt Gordon Piatt</p> <p>"A" 7" 5"</p> <p>E5-307N E5-307T</p>
 <p>Fulton Boiler</p> <p>E5-282C</p>	 <p>Gold Star Gold Star</p> <p>"A" 4" 5"</p> <p>E5-306 E5-307</p>	 <p>Gordon Piatt</p> <p>E5-307W</p>
 <p>Fulton Boiler</p> <p>E5-283A</p>	 <p>Gordon Piatt</p> <p>E5-307A</p>	 <p>Gould Gould Gould Gould</p> <p>"A" 5" 6" 7" 8"</p> <p>E5-308 E5-309 E5-310 E5-311</p>
 <p>Fulton Boiler</p> <p>E5-283B</p>	 <p>Gordon Piatt</p> <p>E5-307B</p>	 <p>Heil</p> <p>E5-330</p>
 <p>Fulton Boiler</p> <p>E5-284</p>	 <p>Gordon Piatt Gordon Piatt Gordon Piatt</p> <p>"A" 5" 7" 9"</p> <p>E5-307B E5-307C E5-307D</p>	 <p>Heil Heil</p> <p>"A" 2-1/4" 4"</p> <p>E5-330A E5-330B</p>
 <p>Fulton Boiler</p> <p>E5-285</p>	 <p>Gordon Piatt Gordon Piatt Gordon Piatt Gordon Piatt</p> <p>"A" 4" 5" 6" 8"</p> <p>E5-307F E5-307P E5-307G E5-307H</p>	 <p>Heil</p> <p>E5-331A</p>
 <p>General Automatic</p> <p>E5-290</p>	 <p>Gordon Piatt Gordon Piatt Gordon Piatt Gordon Piatt</p> <p>"A" 7-3/4" 13-1/2"</p> <p>E5-307I E5-307J</p>	 <p>Heil</p> <p>E5-331B</p>
 <p>General Electric</p> <p>E5-291</p>	 <p>Gordon Piatt</p> <p>E5-307K</p>	 <p>Heil Heil</p> <p>"A" 1-1/4" 3"</p> <p>E5-331C E5-331D</p>
 <p>General Electric</p> <p>E5-296</p>	 <p>Gordon Piatt</p> <p>E5-307O</p>	 <p>Homelite</p> <p>E5-337A</p>
 <p>General Electric</p> <p>E5-298</p>	 <p>Gordon Piatt Gordon Piatt Gordon Piatt</p> <p>"A" 4" 6" 8"</p> <p>E5-307Q E5-307R E5-307S</p>	 <p>Homestead</p> <p>E5-338</p>
 <p>General Electric</p> <p>E5-299</p>	 <p>General Electric</p> <p>E5-299A</p>	 <p>Hupp</p> <p>E5-339</p>
 <p>General Electric</p> <p>E5-300</p>		



**Westwood** electrodes & insulators

HIGH DIELECTRIC STRENGTH • PRECISION DIMENSIONS

 Homestead E5-340	 Iron Fireman E5-357B	 Iron Fireman E5-357Y
 Homestead E5-341	 Iron Fireman E5-357C	 Iron Fireman E5-358
 Homestead E5-341A	 Iron Fireman E5-357D	 Iron Fireman E5-363
 Industrial Combustion E5-342	 Iron Fireman E5-357E	 Iron Fireman E5-364
 Industrial Combustion E5-343	 Iron Fireman E5-357F	 Iron Fireman E5-365
 Industrial Combustion E5-343A	 Iron Fireman E5-357I	 Iron Fireman E5-365B
 Industrial Combustion E5-344	 Iron Fireman E5-357J	 Iron Fireman E5-365D
 Industrial Combustion E5-344A	 Iron Fireman E5-357K	 Iron Fireman E5-366
 Industrial Combustion E5-345	 Iron Fireman E5-357L	 Iron Fireman E5-366A
 Industrial Combustion E5-345A	 Iron Fireman E5-357M	 Iron Fireman E5-366D
 International E5-348	 Iron Fireman E5-357N	 Johnson E5-371
 International E5-348A	 Iron Fireman E5-357O	 Johnson E5-371A
 International E5-349	 Iron Fireman E5-357R	 Johnson E5-372
 Iron Fireman E5-356	 Iron Fireman E5-357S	 Johnson E5-373
 Iron Fireman E5-357	 Iron Fireman E5-357U	 Johnson E5-373A
 Iron Fireman E5-357A	 Iron Fireman E5-357W	 Johnson E5-375
		 Johnson E5-375A

Please order by No.

rev. 3-1-11

**E8**



**Westwood** electrodes & insulators

HIGH DIELECTRIC STRENGTH • PRECISION DIMENSIONS

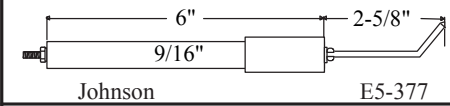
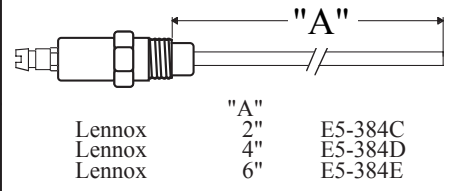
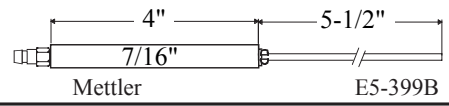
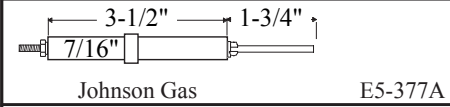
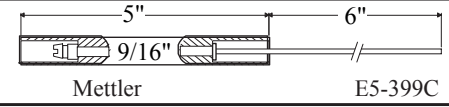
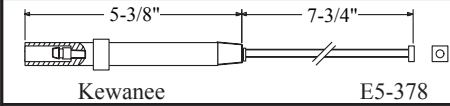
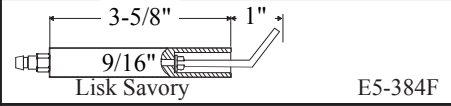
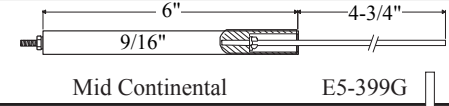
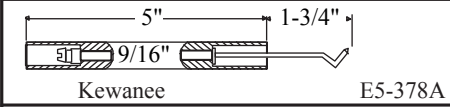
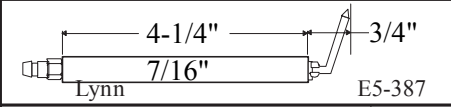
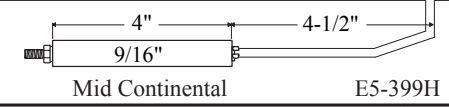
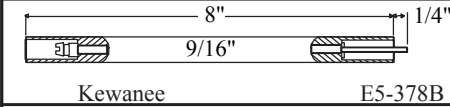
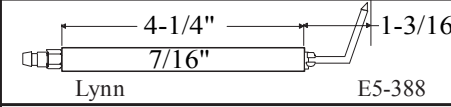
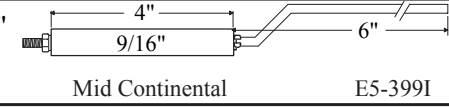
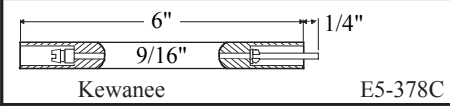
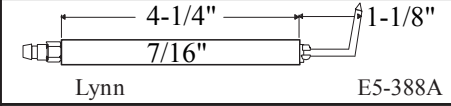
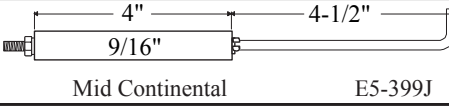
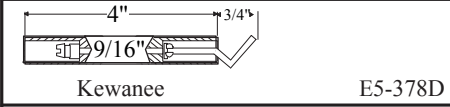
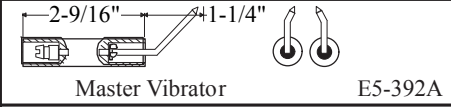
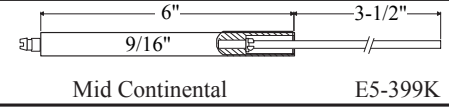
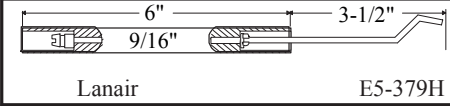
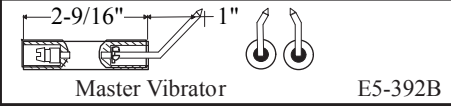
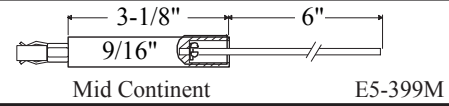
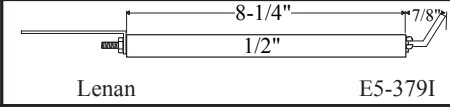
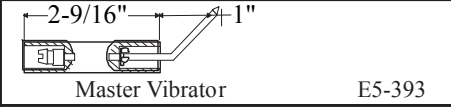
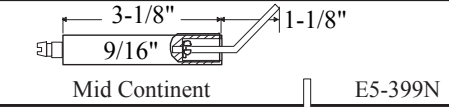
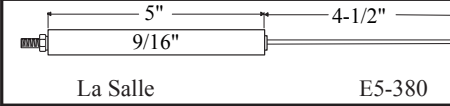
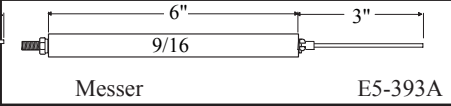
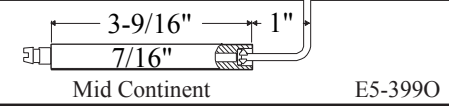
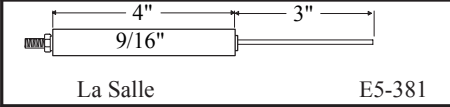
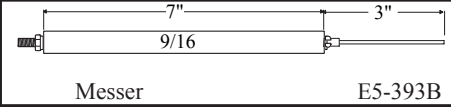
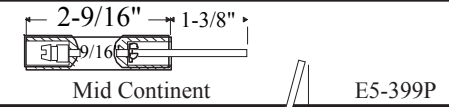
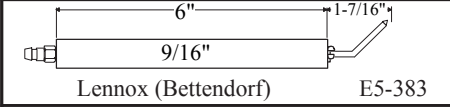
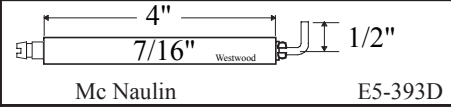
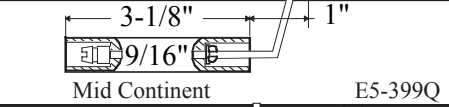
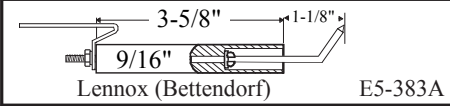
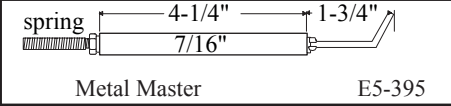
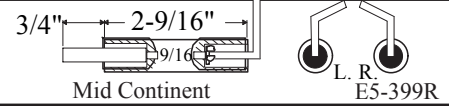
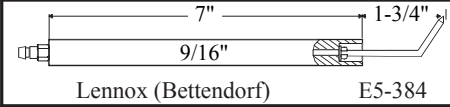
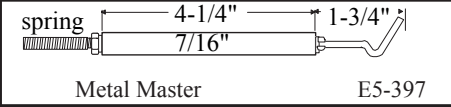
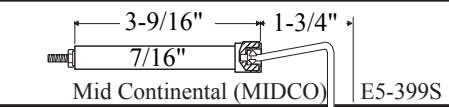
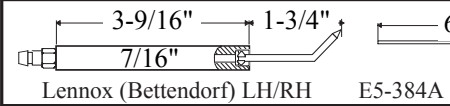
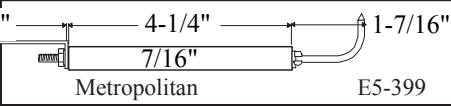
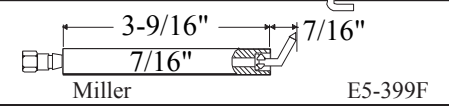
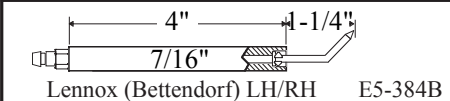
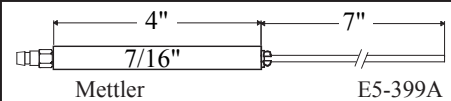
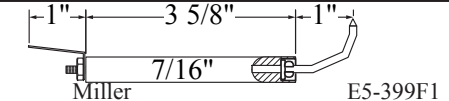
 <p>Johnson E5-377</p>	 <p>Lennox E5-384C Lennox E5-384D Lennox E5-384E</p>	 <p>Mettler E5-399B</p>
 <p>Johnson Gas E5-377A</p>	<p>"A" 2" E5-384C 4" E5-384D 6" E5-384E</p>	 <p>Mettler E5-399C</p>
 <p>Kewanee E5-378</p>	 <p>Lisk Savory E5-384F</p>	 <p>Mid Continental E5-399G</p>
 <p>Kewanee E5-378A</p>	 <p>Lynn E5-387</p>	 <p>Mid Continental E5-399H</p>
 <p>Kewanee E5-378B</p>	 <p>Lynn E5-388</p>	 <p>Mid Continental E5-399I</p>
 <p>Kewanee E5-378C</p>	 <p>Lynn E5-388A</p>	 <p>Mid Continental E5-399J</p>
 <p>Kewanee E5-378D</p>	 <p>Master Vibrator E5-392A</p>	 <p>Mid Continental E5-399K</p>
 <p>Lanair E5-379H</p>	 <p>Master Vibrator E5-392B</p>	 <p>Mid Continent E5-399M</p>
 <p>Lenan E5-379I</p>	 <p>Master Vibrator E5-393</p>	 <p>Mid Continent E5-399N</p>
 <p>La Salle E5-380</p>	 <p>Messer E5-393A</p>	 <p>Mid Continent E5-399O</p>
 <p>La Salle E5-381</p>	 <p>Messer E5-393B</p>	 <p>Mid Continent E5-399P</p>
 <p>Lennox (Bettendorf) E5-383</p>	 <p>Mc Naulin E5-393D</p>	 <p>Mid Continent E5-399Q</p>
 <p>Lennox (Bettendorf) E5-383A</p>	 <p>Metal Master E5-395</p>	 <p>Mid Continent E5-399R</p>
 <p>Lennox (Bettendorf) E5-384</p>	 <p>Metal Master E5-397</p>	 <p>Mid Continental (MIDCO) E5-399S</p>
 <p>Lennox (Bettendorf) LH/RH E5-384A</p>	 <p>Metropolitan E5-399</p>	 <p>Miller E5-399F</p>
 <p>Lennox (Bettendorf) LH/RH E5-384B</p>	 <p>Mettler E5-399A</p>	 <p>Miller E5-399F1</p>

**Westwood** electrodes & insulators

HIGH DIELECTRIC STRENGTH • PRECISION DIMENSIONS

<p>Miller E5-400A</p>	<p>M&amp;H (with Bracket) E5-409C-2</p>	<p>Nu-Way E5-418F</p>
<p>MSO Combustion E5-390</p>	<p>M&amp;H E5-409E</p>	<p>Nu-Way E5-419</p>
<p>MSO Combustion E5-391</p>	<p>M&amp;H E5-409F</p>	<p>Nu-Way E5-420</p>
<p>Monarch E5-400</p>	<p>M&amp;H E5-409G</p>	<p>Nu-Way E5-420A</p>
<p>Mueller E5-401</p>	<p>M&amp;H E5-409H</p>	<p>Nu-Way E5-420A1</p>
<p>Morrison E5-404</p>	<p>M&amp;H E5-409J</p>	<p>Nu-Way E5-420B</p>
<p>Mt Hawley E5-405</p>	<p>M&amp;H E5-409K</p>	<p>Nu-Way E5-420C</p>
<p>Mt Hawley RH/LH E5-406A</p>	<p>M&amp;H E5-407</p>	<p>Nu-Way E5-421</p>
<p>M&amp;H E5-407A</p>	<p>National Airoil E5-411</p>	<p>Nu-Way E5-425</p>
<p>M&amp;H E5-408</p>	<p>National Airoil E5-412</p>	<p>Nu-Way E5-428</p>
<p>M&amp;H E5-409</p>	<p>National Airoil E5-415</p>	<p>Nu-Way E5-429</p>
<p>M&amp;H E5-409A</p>	<p>National Radiator E5-416</p>	<p>Nu-Way E5-429H</p>
<p>M&amp;H E5-409B</p>	<p>Northeast E5-417</p>	<p>Nu-Way E5-429A 1/2" E5-429D 2"                      E5-429B 1" E5-429F 2-1/2"                      E5-429C 1-1/2" E5-429G 3-1/2"</p>
<p>M&amp;H E5-409C</p>	<p>Nu-Way E5-418</p>	<p>Nu-Way E5-418A</p>
<p>M&amp;H E5-409D</p>	<p>Nu-Way E5-418B</p>	<p>Nu-Way E5-430</p>
		<p>Nu-Way E5-430A</p>

Please order by No.





**Westwood** electrodes & insulators

HIGH DIELECTRIC STRENGTH • PRECISION DIMENSIONS

<p>Oil Equipment E5-432</p>	<p>Petro 1-1/2" E5-468B Petro 2" E5-468C Petro 18" E5-468D</p>	<p>Power Flame E5-477I</p>
<p>Orr &amp; Sembower E5-443</p>	<p>Power Flame E5-475-1</p>	<p>Power Flame E5-477J</p>
<p>Orr &amp; Sembower E5-448</p>	<p>Power Flame E5-475</p>	<p>Power Flame E5-477K</p>
<p>Orr &amp; Sembower E5-449</p>	<p>Power Flame E5-475A</p>	<p>Power Flame E5-478</p>
<p>Orr &amp; Sembower E5-451</p>	<p>Power Flame (Kanthal tip) E5-475B</p>	<p>Power Flame E5-478A</p>
<p>Orr &amp; Sembower E5-452</p>	<p>Power Flame E5-477</p>	<p>Power Flame E5-478B</p>
<p>Orr &amp; Sembower E5-453</p>	<p>Power Flame E5-478C</p>	<p>Power Flame E5-478D</p>
<p>Peabody E5-457</p>	<p>Power Flame 5.81" .50" E5-477A Power Flame 6.44" .38" E5-477B Power Flame 6.88" .47" E5-477C</p>	<p>Power Flame E5-478E</p>
<p>Peabody E5-458</p>	<p>Power Flame 5.81" 6.30" E5-477A-1 Power Flame 6.44" 6.69" E5-477B-1 Power Flame 6.88" 8.66" E5-477C-1</p>	<p>Power Flame E5-479A</p>
<p>Penn Boiler E5-461</p>	<p>Power Flame E5-479B</p>	<p>Power Flame E5-479C</p>
<p>Petro E5-465</p>	<p>Power Flame E5-477D</p>	<p>Power Flame E5-479D</p>
<p>Petro E5-465B</p>	<p>Power Flame E5-477E</p>	<p>Power Flame E5-479E</p>
<p>Petro E5-466</p>	<p>Power Flame E5-477F</p>	<p>Power Flame E5-479E1</p>
<p>Petro 1-1/2" E5-467 Petro 2" E5-467A Petro 18" E5-467B Petro 6" E5-467G</p>	<p>Power Flame (Stainless tip) E5-477G</p>	<p>Power Flame E5-477H</p>
<p>Petro E5-468A</p>		

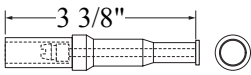
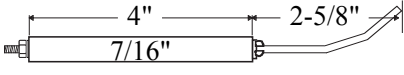
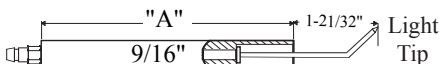
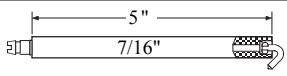
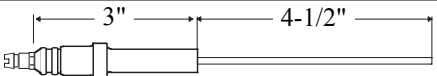
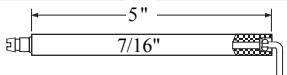
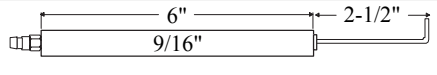
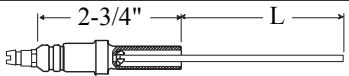
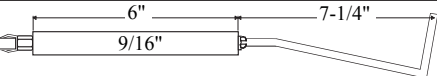
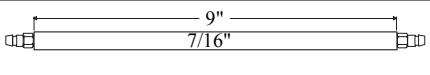
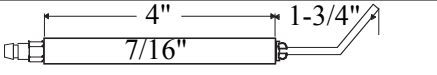
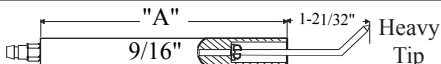
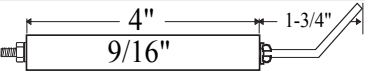
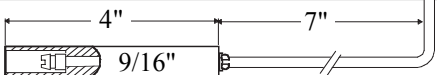
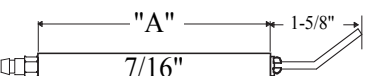
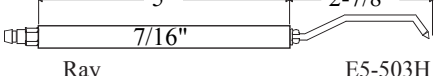
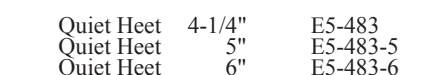
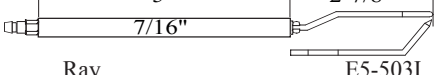
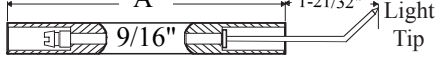
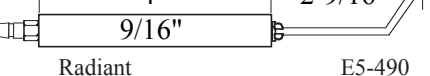
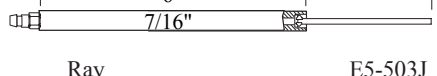
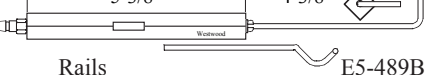
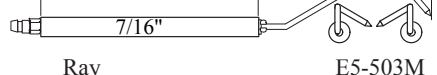

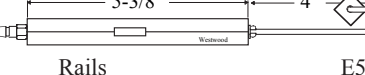
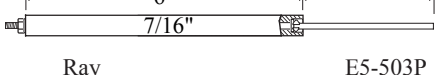
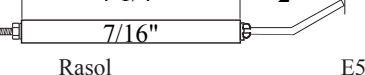
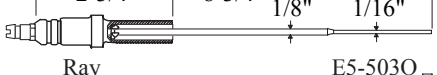
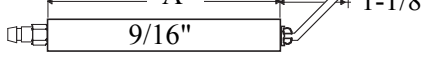
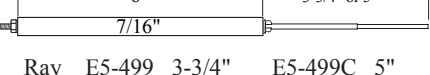
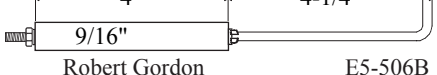
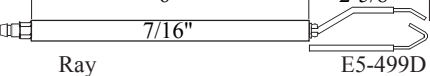
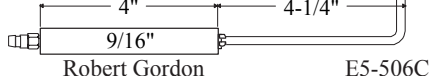
**Westwood** electrodes & insulators

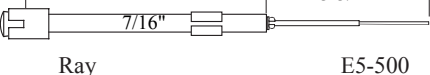
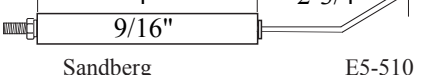
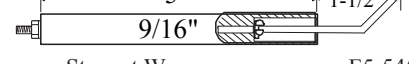
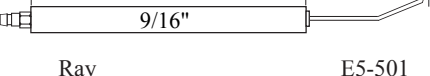
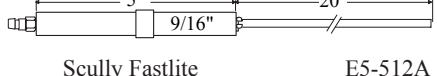
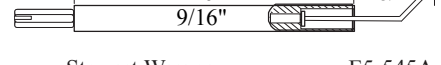
HIGH DIELECTRIC STRENGTH • PRECISION DIMENSIONS

 <p>Preferred Utilities E5-471A</p>	 <p>Ray E5-502</p>	 <p>Light Tip</p>
 <p>PVI E5-473F</p>	 <p>Ray E5-503A</p>	<p>Shellhead 4" E5-513-4 Shellhead 5" E5-513-5 Shellhead 6" E5-513-6 Shellhead 7" E5-513-7 Shellhead 8" E5-513-8 Shellhead 9" E5-513-9 Shellhead 10" E5-513-10 Shellhead 11" E5-513-11 Shellhead 12" E5-513-12 Shellhead 13" E5-513-13 Shellhead 14" E5-513-14</p>
 <p>PVI E5-473G</p>	 <p>Ray E5-503D</p>	
 <p>Pyronics E5-474C-1 6" E5-474C-2 12"</p>	 <p>Ray E5-503E</p>	
 <p>Pyronics E5-474E</p>	 <p>Ray E5-503F</p>	 <p>Heavy Tip</p>
 <p>Quiet Automatic E5-480</p>	 <p>Ray E5-503G</p>	<p>Shellhead 4" E5-514-4 Shellhead 5" E5-514-5 Shellhead 6" E5-514-6 Shellhead 7" E5-514-7 Shellhead 8" E5-514-8 Shellhead 9" E5-514-9 Shellhead 10" E5-514-10 Shellhead 11" E5-514-11 Shellhead 12" E5-514-12 Shellhead 13" E5-514-13 Shellhead 14" E5-514-14</p>
 <p>Quiet Heet 4-1/4" E5-483 Quiet Heet 5" E5-483-5 Quiet Heet 6" E5-483-6</p>	 <p>Ray E5-503H</p>	
 <p>Radiant E5-490</p>	 <p>Ray E5-503I</p>	 <p>Light Tip</p>
 <p>Rails E5-489B</p>	 <p>Ray E5-503J</p>	<p>Shellhead 5" E5-515-5 Shellhead 6" E5-515-6 Shellhead 7" E5-515-7 Shellhead 8" E5-515-8</p>
 <p>Rails E5-489C</p>	 <p>Ray E5-503M</p>	 <p>Heavy Tip</p>
 <p>Rasol E5-494</p>	 <p>Ray E5-503P</p>	<p>Shellhead 5" E5-516-5 Shellhead 6" E5-516-6</p>
 <p>Ray E5-499</p>	 <p>Ray E5-503Q</p>	 <p>Light Tip</p>
 <p>Ray E5-499 3-3/4" E5-499C 5"</p>	 <p>Robert Gordon E5-506B</p>	<p>Silent Glow 3" E5-523 Silent Glow 4" E5-524 Silent Glow 5" E5-525 Silent Glow 6" E5-526 Silent Glow 11-3/4" E5-527</p>
 <p>Ray E5-499D</p>	 <p>Robert Gordon E5-506C</p>	 <p>Silent Glow E5-523A</p>
 <p>Ray E5-500</p>	 <p>Sandberg E5-510</p>	 <p>Stewart Warner E5-545</p>
 <p>Ray E5-501</p>	 <p>Scully Fastlite E5-512A</p>	 <p>Stewart Warner E5-545A</p>

**Westwood** electrodes & insulators

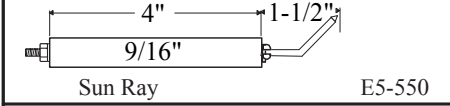
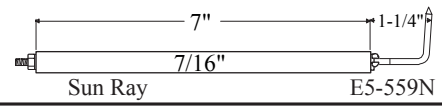
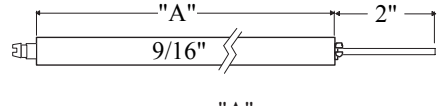
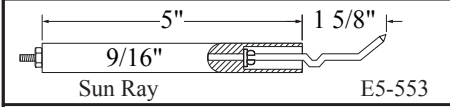
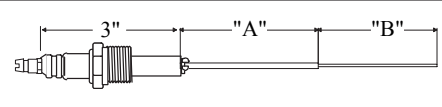
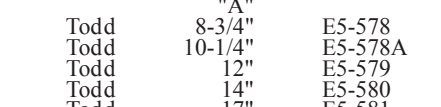
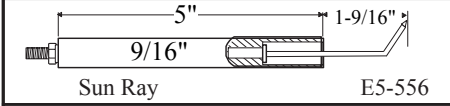
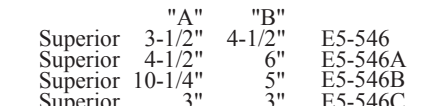
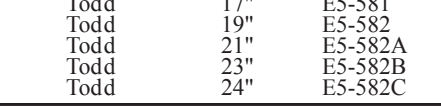
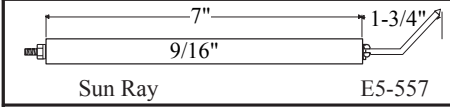
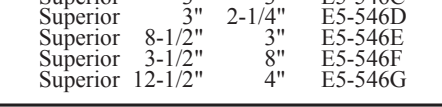
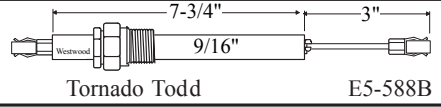
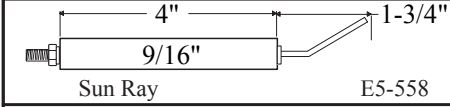
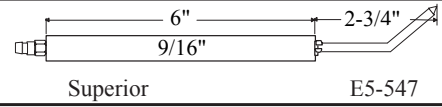
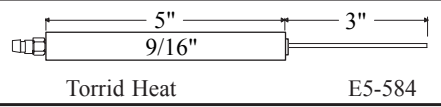
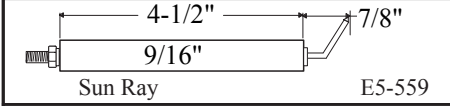
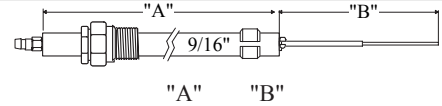
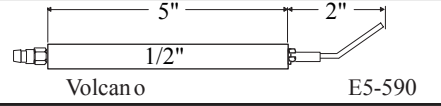
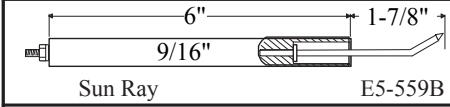
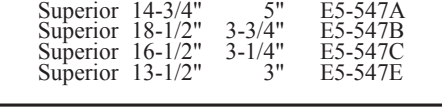
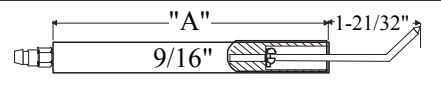
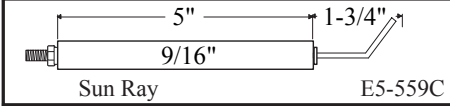
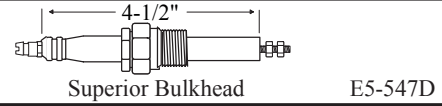
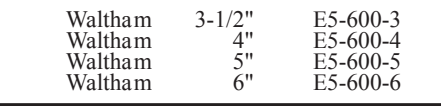
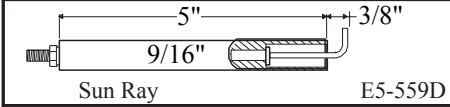
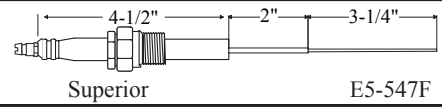
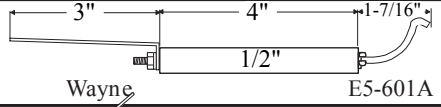
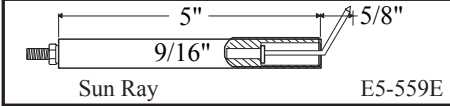
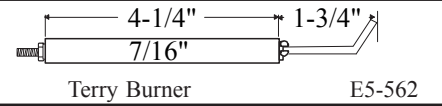
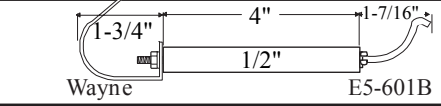
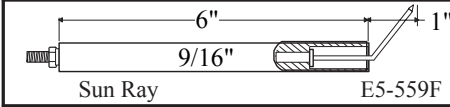
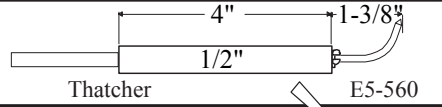
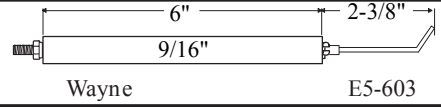
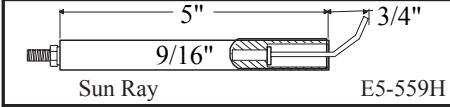
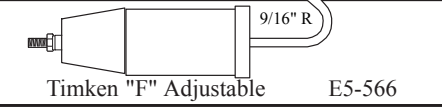
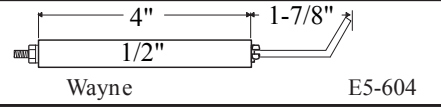
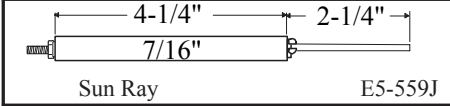
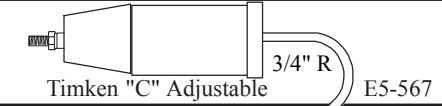
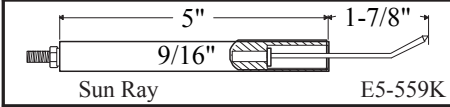
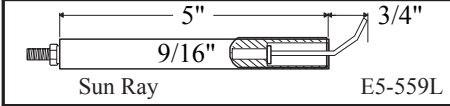
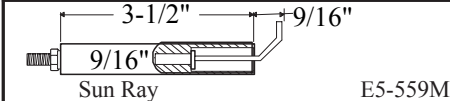
HIGH DIELECTRIC STRENGTH • PRECISION DIMENSIONS

 Sun Ray E5-550	 Sun Ray E5-559N	 Todd "A" 8-3/4" E5-578 Todd 10-1/4" E5-578A Todd 12" E5-579 Todd 14" E5-580 Todd 17" E5-581 Todd 19" E5-582 Todd 21" E5-582A Todd 23" E5-582B Todd 24" E5-582C
 Sun Ray E5-553	 Superior "A" "B" Superior 3-1/2" 4-1/2" E5-546 Superior 4-1/2" 6" E5-546A Superior 10-1/4" 5" E5-546B Superior 3" 3" E5-546C Superior 3" 2-1/4" E5-546D Superior 8-1/2" 3" E5-546E Superior 3-1/2" 8" E5-546F Superior 12-1/2" 4" E5-546G	 Tornado Todd E5-588B
 Sun Ray E5-556	 Superior E5-547	 Torrid Heat E5-584
 Sun Ray E5-557	 Sun Ray E5-558	 Volcano E5-590
 Sun Ray E5-559	 Superior Bulkhead E5-547D	 Waltham 3-1/2" E5-600-3 Waltham 4" E5-600-4 Waltham 5" E5-600-5 Waltham 6" E5-600-6
 Sun Ray E5-559B	 Superior E5-547F	 Wayne E5-601A
 Sun Ray E5-559C	 Terry Burner E5-562	 Wayne E5-601B
 Sun Ray E5-559D	 Thatcher E5-560	 Wayne E5-603
 Sun Ray E5-559E	 Timken "F" Adjustable E5-566	 Wayne E5-604
 Sun Ray E5-559F	 Timken "C" Adjustable E5-567	 Wayne E5-604A
 Sun Ray E5-559G	 Todd E5-577A	 Wayne E5-604B
 Sun Ray E5-559H	 Todd "A" 5" E5-579A Todd 13" E5-579B Todd 16" E5-579C Todd 19" E5-579D Todd 21" E5-579E Todd 22" E5-579F	 Wayne E5-604C
 Sun Ray E5-559I	 Wayne E5-604D	
 Sun Ray E5-559J		
 Sun Ray E5-559K		
 Sun Ray E5-559L		
 Sun Ray E5-559M		

**Westwood** electrodes & insulators

HIGH DIELECTRIC STRENGTH • PRECISION DIMENSIONS

 Wayne E5-605	 Waywolf E5-606A	 York E5-631C
 Wayne E5-605A	 Webster Engineering E5-599E	 York E5-632
 Wayne E5-605B	 Webster Engineering E5-599F	 York E5-632A
 Wayne E5-605C	 Webster Engineering E5-599G	 York E5-632B
 Wayne E5-605D	 Webster Engineering E5-599J	 York E5-632C
 Wayne E5-605E	 Webster Engineering E5-599K	 York E5-632D
 Wayne Blue Angel E5-605F	 Weil-McLain, electrode only E5-598 Weil-McLain electrode w/leads E5-598A Leads only (former WMK-150) E5-598B	 York E5-632E
 Wayne Blue Angel E5-605F1		 York E5-633
 Wayne Blue Angel (with pointed tip) E5-605F2		 York E5-634
 Wayne E5-605G		 York E5-634A
 Wayne E5-605H		 York E5-635
 Wayne E5-605I	 Williams E5-624	 York (Levittown) E5-635
 Wayne E5-605J	 John Wood E5-623	 York E5-636
 Wayne E5-605K	 York E5-637	 York E5-638
 Wayne E5-605L	 York E5-630	 York E5-631
 Wayne E5-605M	 York E5-631A	 York E5-638
 Wayne E5-605N	 York E5-631B	 York E5-639
 Wayne E5-605P	 York E5-629	 Zenith E5-640
 Wayne E5-606	 York E5-630A	 Zenith E5-641

Please order by  No.

rev. 1-1-09

**E14**



Westwood

**ELECTRODE KITS**

FOR THE SERVICE PROFESSIONAL

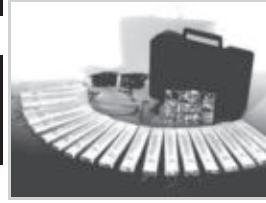
**ELECTRODE & INSULATOR KITS****Serviceman's Deluxe Kit****OEM Electrodes - 2 ea.**

ABC: E5-146

Beckett: E5-151E, E5-1510

Carlin: E5-188B, E5-188N, E5-188K

Quiet Heat: E5-483

Wayne: E5-604, E5-605, E5-605B,

E5-605F, E5-606

**Rajah™ Terminals - 10 ea.**

E9-CT, E9-SS, E9-R-2, E9-RAC, E9-SF,

E9-BS 6-32, E9-BS 10-32,

E9-HS 6-32 (5 ea.), E9-HS 10-32 (5 ea.),

6-32 nut, 10-32 nut

**Standard Electrodes - 2 ea.**

E5-1M4, E5-2M4, E5-2M5, E5-2M6,

E5-4M4, E5-3M4, E5-3M5, E5-3M6

**Also includes**

5 feet of GTO-15 ignition cable

1 set (2) T100-230 electrode benders

1 - T100-220 electrode gauge

1 set (2) T100-70 jumpers

1 - NAS gauge™ nozzle gauge

1 - Coupler Popper™ tool

1 - Plastic carrying case

 No. E5-2001
**Serviceman's Super Kits**

Same contents as the E5-2001 Deluxe Kit, less the NAS gauge™ and Coupler Popper™ in a plastic carrying case

 No. E5-1897

Same contents as the E5-2001 Deluxe Kit, less the NAS gauge™ and Coupler Popper™ in a cardboard box

 No. E5-1897-C
**ELECTRODE & INSULATOR ROLL-UP KITS****Contains:****Electrodes - 2 ea.**

E5-3M4 (9/16"x4"), E5-3M5 (9/16"x5"),

E5-3M6 (9/16"x6"), E5-3F5 (9/16"x5"),

E5-483 (Quiet Heat)

**Insulators - 2 ea.**

E5-1M4-1/4 (7/16"x4-1/4"), E5-4M4 (1/2"x4"),

E5-2M4 (9/16"x4"), E5-2M5 (9/16"x5"),

E5-3M4 (9/16"x4")

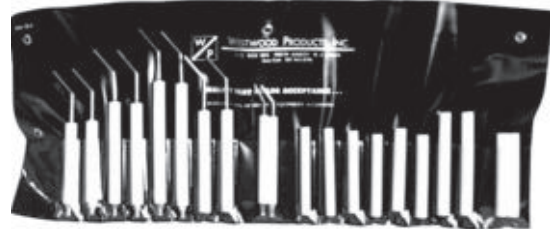
 No. E5-595
**Contains:****Electrodes - 2 ea.**

E5-188N (Carlin), E5-151E (Beckett),

E5-605 (Wayne), E5-2M4 (9/16"x4"),

E5-2M5 (9/16"x5"), E5-2M6 (9/16"x6"),

E5-2F5 (female 5"), E5-2F6 (female 6")

**Insulators - 2 ea.**

E5-1M4-1/4 (7/16"x4-1/4"), E5-3M4 (9/16"x4"),

E5-2M4 (9/16"x4"), E5-2M5 (9/16"x5"),

E5-2M6 (9/16"x6"), E5-2F5 (female 5"),

E5-2F6 (female 6"), E5-4M4 (1/2"x4")

 No. E5-920

Westwood

**ELECTRODE KITS**

FOR THE SERVICE PROFESSIONAL

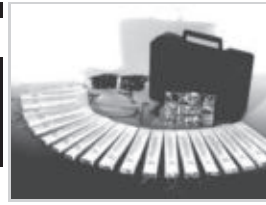
**ELECTRODE & INSULATOR ROLL-UP KITS (Continued)**

For Servicing  
**Beckett Burners**

Contains these electrodes:

4 · E5-151E	2 · E5-151D
2 · E5-151E1	2 · E5-151R
2 · E5-151O	2 · E5-151G
2 · E5-151F	2 · E5-151J
2 · E5-151	

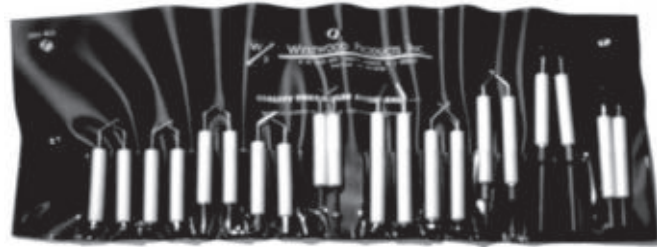

 No. E5-BK-400

For Servicing  
**Carlin Burners**

Contains these electrodes:

4 · E5-188N	2 · E5-188P
4 · E5-188B	2 · E5-188Q
2 · E5-188K	2 · E5-188R3
2 · E5-188R-2	2 · E5-188N4
2 · E5-188H	





 No. E5-CK-300

For Servicing  
**Wayne Burners**

Contains these electrodes:

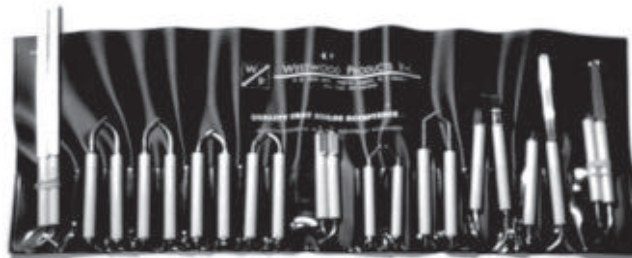
4 · E5-605	2 · E5-605E
4 · E5-606	2 · E5-605C
2 · E5-605B	2 · E5-605D
2 · E5-605F	2 · E5-605F1
2 · E5-604	



 No. E5-WK-500

 Take a look . . .

PORCELAIN CUTTER No. T100-370 on page T17  
&  
RAJAH TERMINAL KITS on page E33

Please order by  No.

rev. 5-1-07

**E16**

Westwood

**AUBURN IGNITION PRODUCTS**

IGNITORS • FLAME RODS • LIQUID LEVEL ELECTRODES

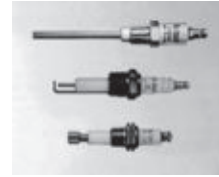

**NOTE: Auburn ignition products part numbers are now "E5-" followed by the former number.**

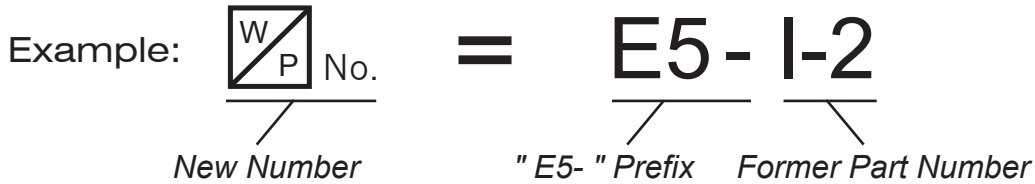

**149T-1 (.090)**

 No.	Ref. No.
E5-149T-1-090	149T-1-090

**I-2-EI-2**

 No.	Ref. No.
E5-I-2-EI-2	I-2-EI-2

**F-68**

 No.	Ref. No.
E5-F-68	F-68

**I-2 Series**

 No.	Ref. No.	"A" DIM.	"B" DIM.
E5-I-2	I-2	8.00	4.50
E5-I-2-1	I-2-1	15.50	12.00
E5-I-2-2	I-2-2	27.50	24.00

**F-140**

 No.	Ref. No.
E5-F-140	

**New!**

\* Dimensions marked with an asterisk are standard lengths - Other lengths available upon request

### AUBURN ELECTRODES

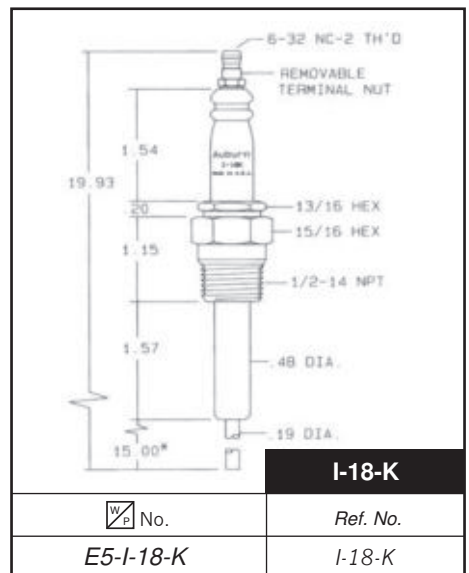
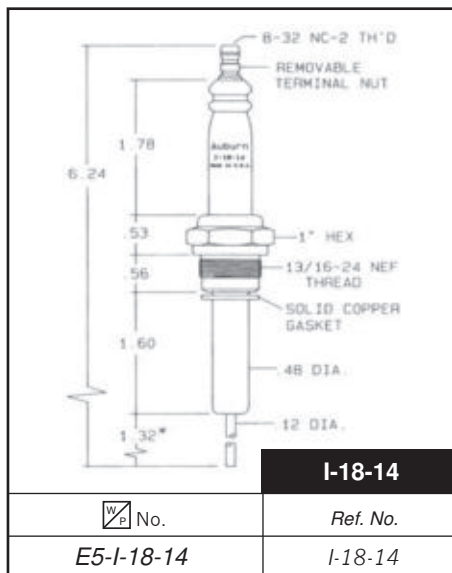
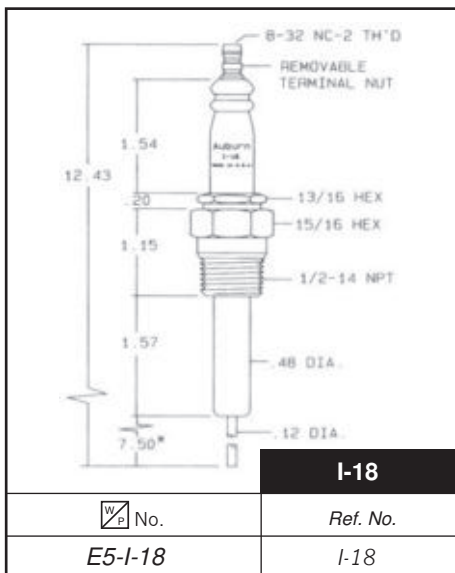
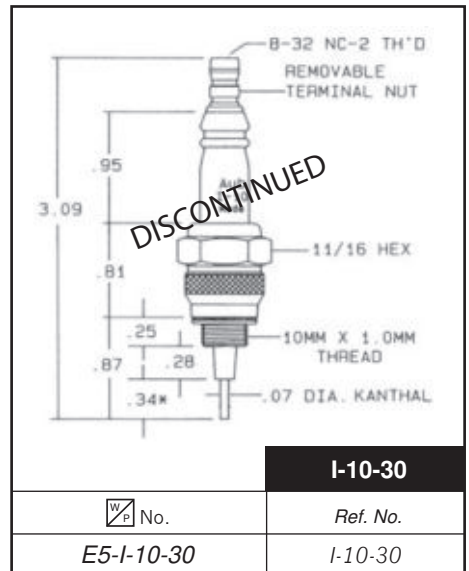
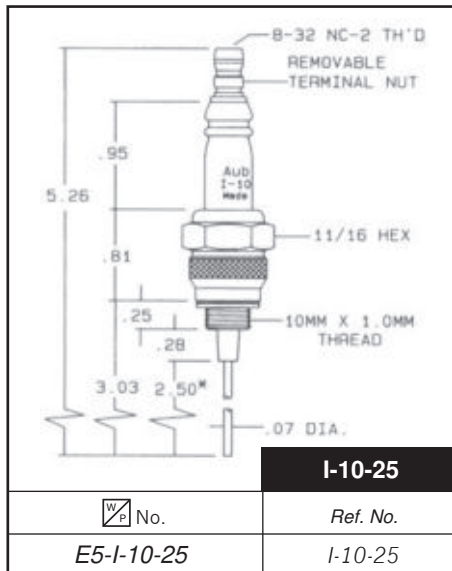
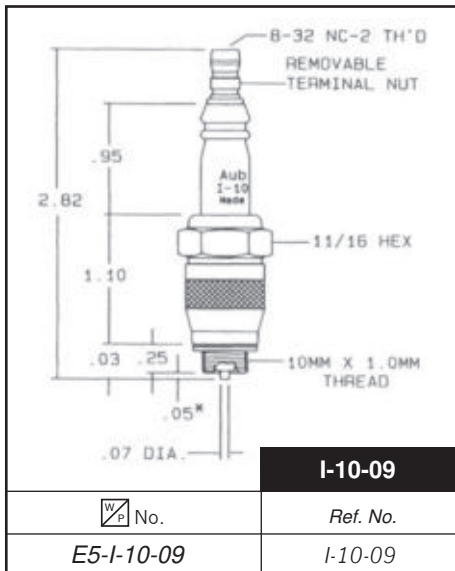
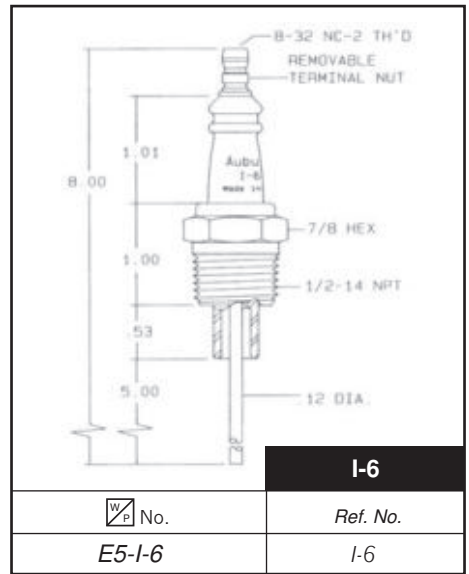
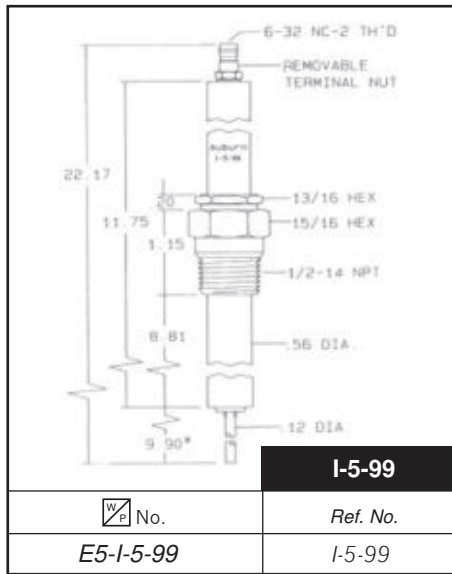
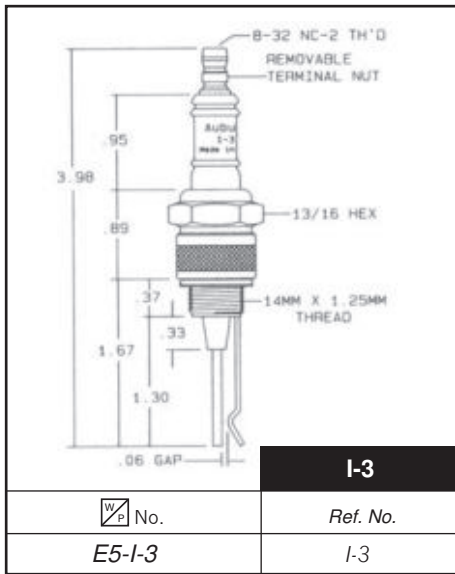

\* Dimensions marked with an asterisk are standard lengths - Other lengths available upon request

Please order by No.

**AUBURN ELECTRODES**

**I-25**

No.	Ref. No.
E5-I-25	I-25

**I-25-3**

No.	Ref. No.
E5-I-25-3	I-25-3

**I-25-4**

No.	Ref. No.
E5-I-25-4	I-25-4

**I-28**

No.	Ref. No.
E5-I-28	I-28

**I-31 Series**

No.	Ref. No.	"A"	"B"	ELEC. MAT.
E5-I-31	I-31	3.68	1.37	NICKEL
E5-I-31-1	I-31-1	4.17	1.87	NICKEL
E5-I-31-2	I-31-2	4.81	2.50	NICKEL
E5-I-31-3	I-31-3	4.17	1.87	INCONEL
E5-I-31-5	I-31-5	6.43	4.12	NICKEL
E5-I-31-6	I-31-6	3.31	1.06	NICKEL

**I-32**

No.	Ref. No.
E5-I-32	I-32

**I-33**

No.	Ref. No.
E5-I-33	I-33

As a major distributor of Auburn Ignition Products, Westwood can special order any Auburn item not shown in this catalog and get it to you fast!

**E5-FI21501**

No.	Ref. No.
E5-FI21501	FI21501

\* Dimensions marked with an asterisk are standard lengths - Other lengths available upon request



**AUBURN ELECTRODES**

**I-63**

No.	Ref. No.
E5-I-63	I-63

**I-64 Series**

No.	Ref. No.	"A"	"B"	GAP	ELEC. MAT.
E5-I-64-1	I-64-1	4.20	1.72	.090	NI
E5-I-64-3	I-64-3	6.24	3.75	.090	NI
E5-I-64-4 <sup>1</sup>	I-64-4	3.60	1.12	.100	NI
E5-I-64-7	I-64-7	4.70	2.21	.100	NI

<sup>1</sup>UL Recognized Component

**I-75-5**

No.	Ref. No.
E5-I-75-5	I-75-5

**I-75-6**

No.	Ref. No.
E5-I-75-6	I-75-6

**I-78**

No.	Ref. No.
E5-I-78	I-78

**I-82**

No.	Ref. No.
E5-I-82	I-82

As a major distributor of Auburn Ignition Products, Westwood can special order any Auburn item not shown in this catalog and get it to you fast!

\* Dimensions marked with an asterisk are standard lengths - Other lengths available upon request



**AUBURN ELECTRODES**

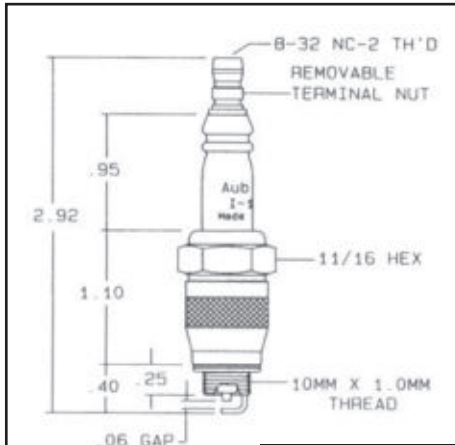

**I-101**

No.	Ref. No.
E5-I-101	I-101

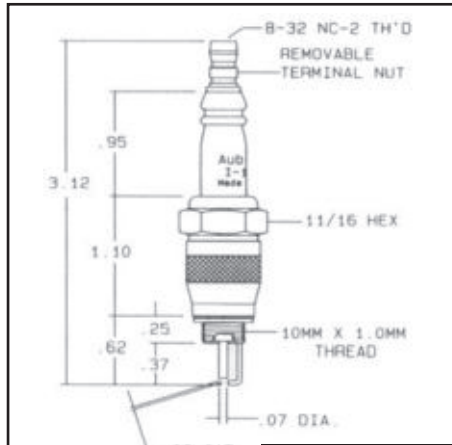

**I-102**

No.	Ref. No.
E5-I-102	I-102

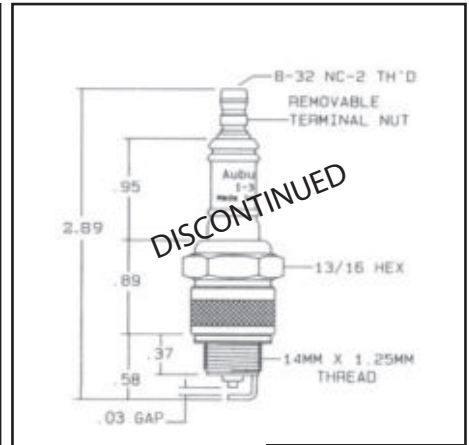

**I-141**

No.	Ref. No.
E5-I-141	I-141

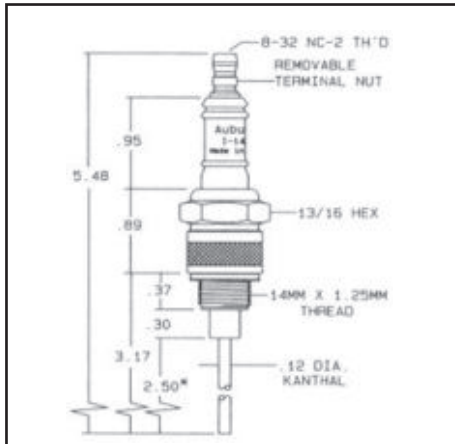

**I-143**

No.	Ref. No.
E5-I-143	I-143

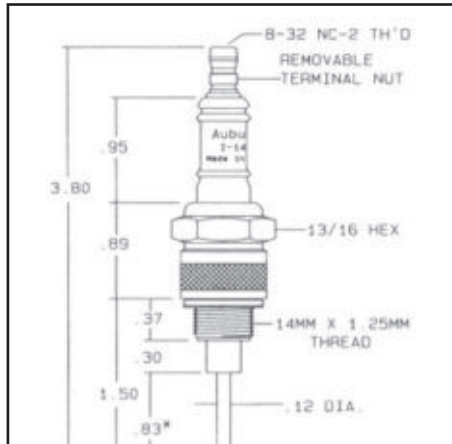

**I-144**

No.	Ref. No.
E5-I-144	I-144

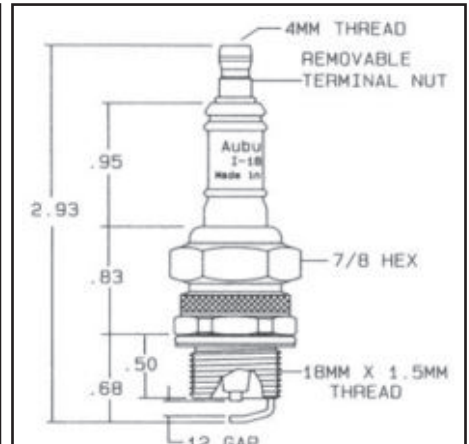

**I-181**

No.	Ref. No.
E5-I-181	I-181

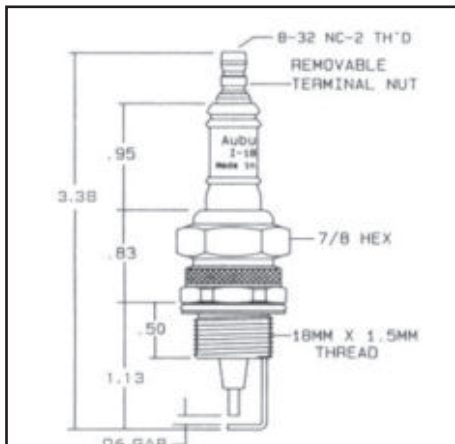

**I-182**

No.	Ref. No.
E5-I-182	I-182

As a major distributor of Auburn Ignition Products, Westwood can special order any Auburn item not shown in this catalog and get it to you fast!

\* Dimensions marked with an asterisk are standard lengths - Other lengths available upon request

**AUBURN ELECTRODES**

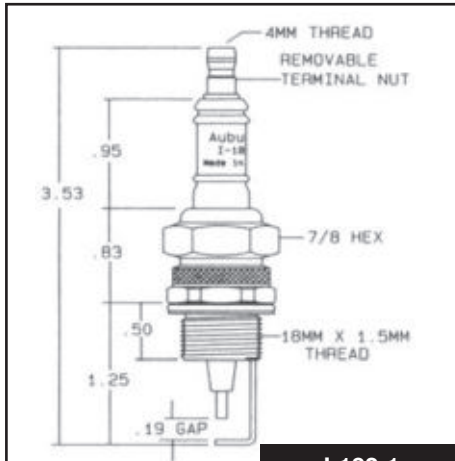

**I-182-1**

No.	Ref. No.
E5-I-182-1	I-182-1

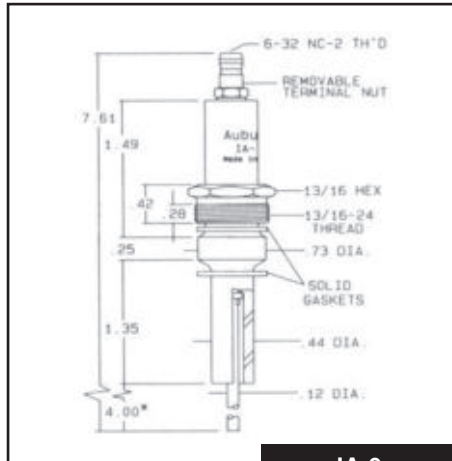

**IA-9**

No.	Ref. No.
E5-IA-9	IA-9

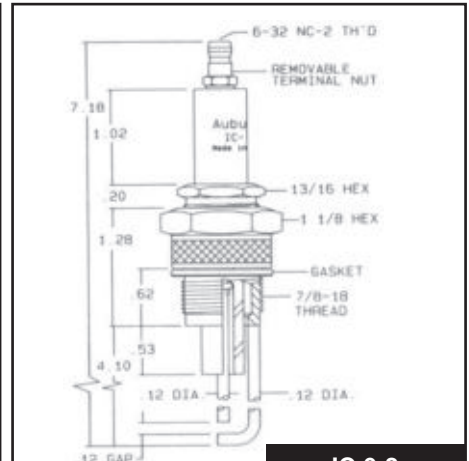

**IC-9-2**

No.	Ref. No.
E5-IC9-2	IC9-2

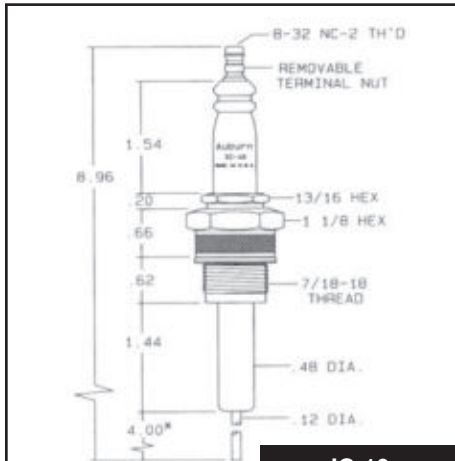

**IC-10**

No.	Ref. No.
E5-IC-10	IC-10

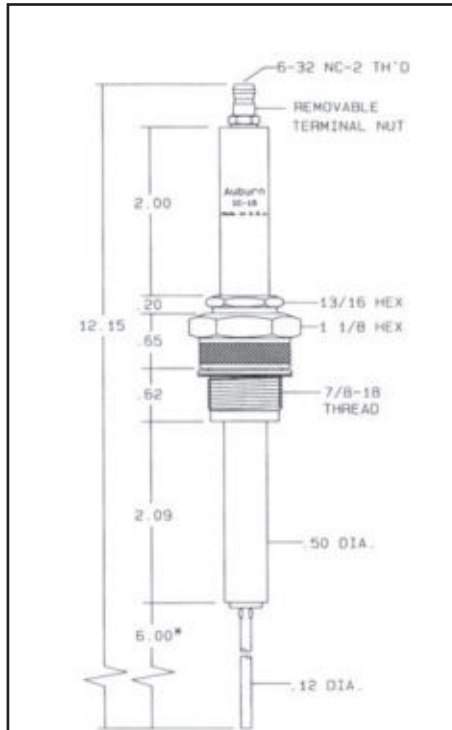

**IC-15**

No.	Ref. No.
E5-IC-15	IC-15

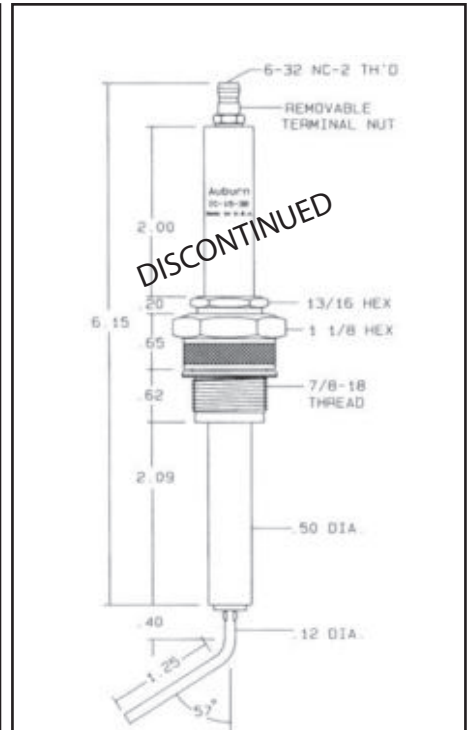

CHROMEL "D"  
Center Wire

**IC-15-3B**

No.	Ref. No.
E5-IC-15-3B	IC-15-3B

As a major distributor of Auburn Ignition Products, Westwood can special order any Auburn item not shown in this catalog and get it to you fast!

\* Dimensions marked with an asterisk are standard lengths - Other lengths available upon request

### AUBURN ELECTRODES

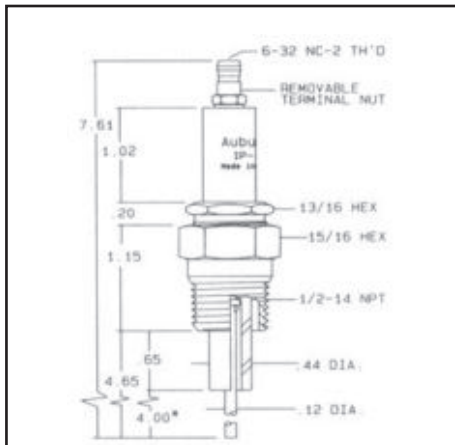

**IP-9**

No.	Ref. No.
E5-IP-9	IP-9

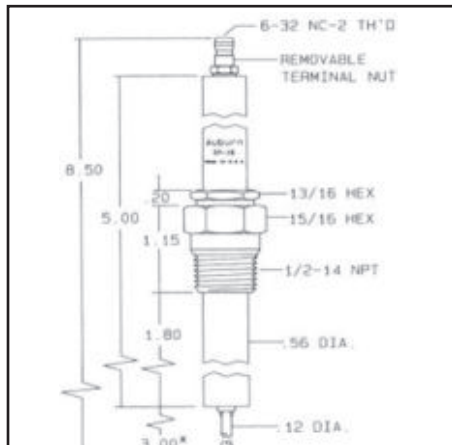

**IP-16**

No.	Ref. No.
E5-IP-16	IP-16

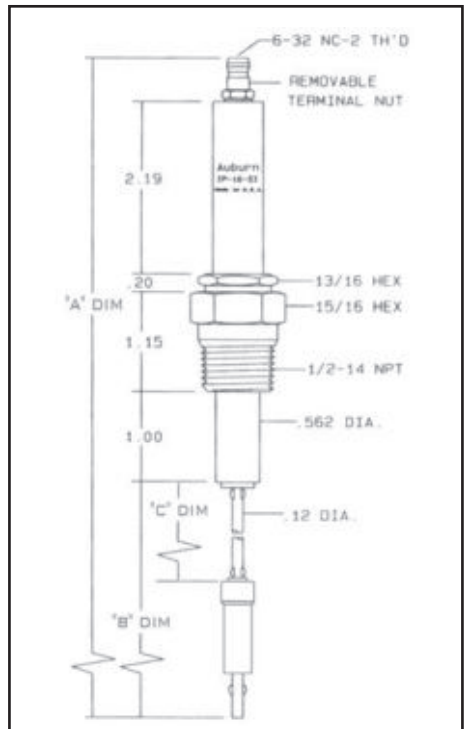

**IP-16-EI Series**

No.	Ref. No.	"A"	"B"	"C"
E5-IP-16-EI	IP-16-EI	18.75	13.25	11.25

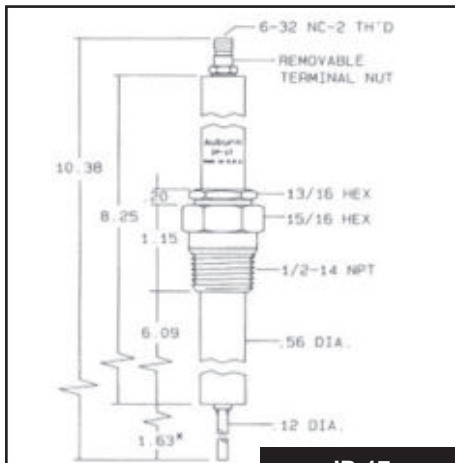

**IP-17**

No.	Ref. No.
E5-IP-17	IP-17

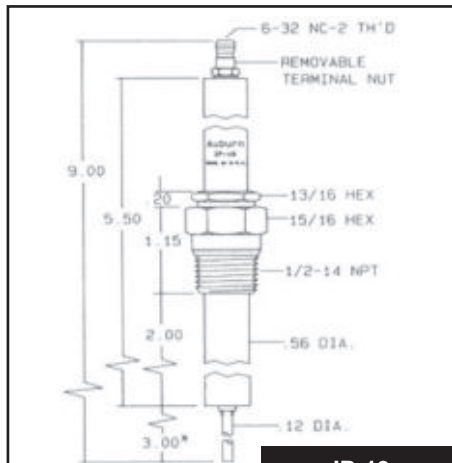

**IP-19**

No.	Ref. No.
E5-IP-19	IP-19

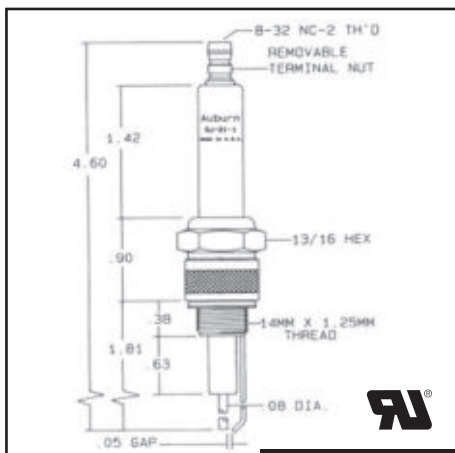

**OJ-21-1**

No.	Ref. No.
E5-OJ-21-1	OJ-21-1

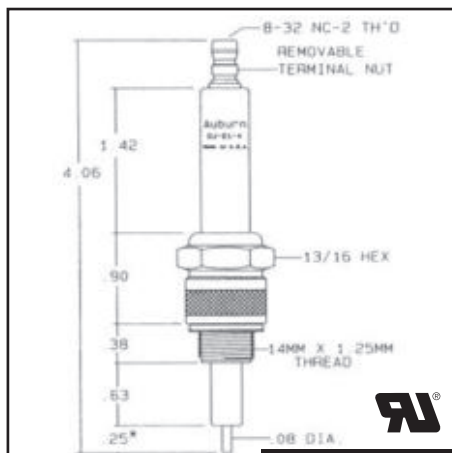

**OJ-21-4**

No.	Ref. No.
E5-OJ-21-4	OJ-21-4

As a major distributor of Auburn Ignition Products, Westwood can special order any Auburn item not shown in this catalog and get it to you fast!

\* Dimensions marked with an asterisk are standard lengths - Other lengths available upon request

**AUBURN ELECTRODES & FLAME RODS**

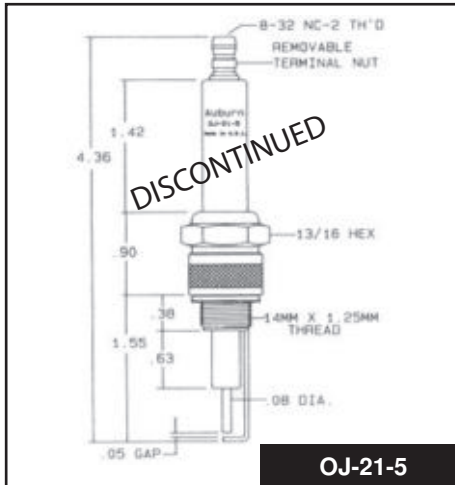

**OJ-21-5**

No.	Ref. No.
E5-OJ-21-5	OJ-21-5

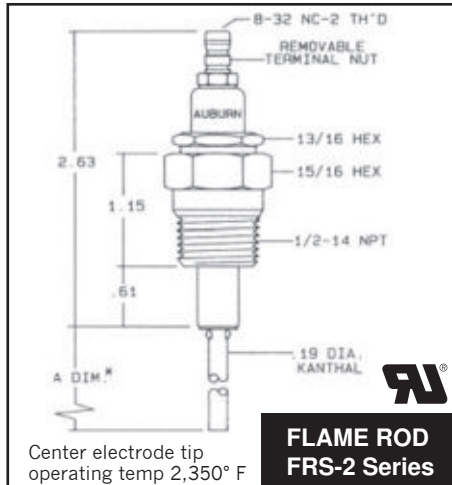

Center electrode tip operating temp 2,350° F

**FLAME ROD FRS-2 Series**

No.	Ref. No.	"A" DIM.
E5-FRS-2-6	FRS-2-6	6"
E5-FRS-2-12	FRS-2-12	12"
E5-FRS-2-18	FRS-2-18	18"
E5-FRS-2-24	FRS-2-24	24"

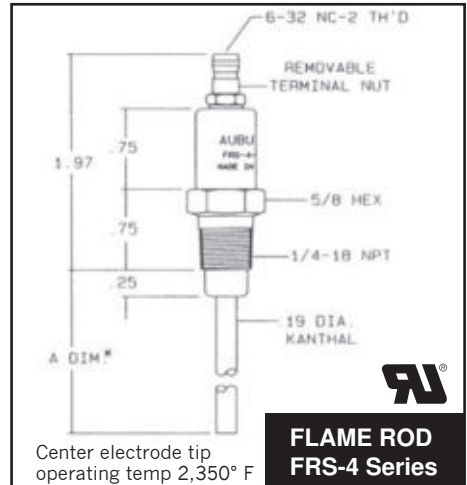

Center electrode tip operating temp 2,350° F

**FLAME ROD FRS-4 Series**

No.	Ref. No.	"A" DIM.
E5-FRS-4-4	FRS-4-4	4"
E5-FRS-4-6	FRS-4-6	6"
E5-FRS-4-7-1/2	FRS-4-7-1/2	7-1/2"
E5-FRS-4-12	FRS-4-12	12"
E5-FRS-4-24	FRS-4-24	24"

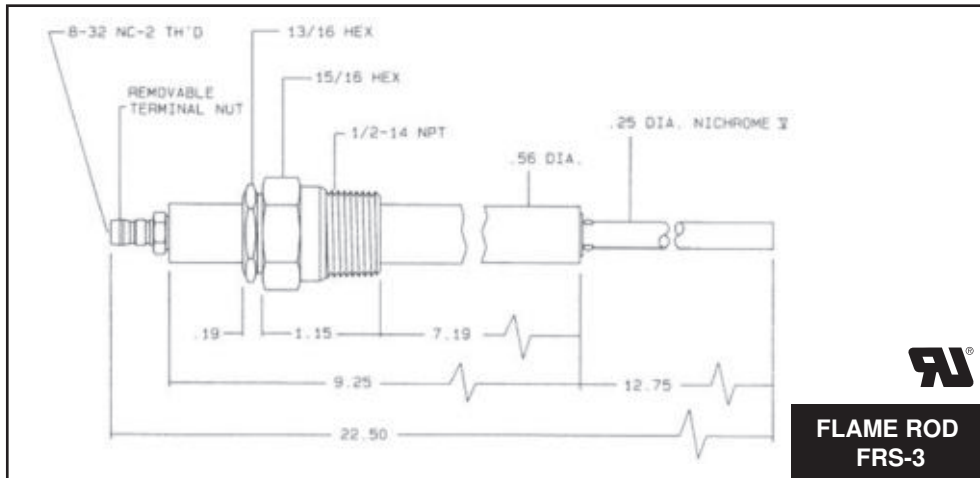

**FLAME ROD FRS-3**

No.	Ref. No.
E5-FRS-3	FRS-3

As a major distributor of Auburn Ignition Products, Westwood can special order any Auburn item not shown in this catalog and get it to you fast!

\* Dimensions marked with an asterisk are standard lengths - Other lengths available upon request

## AUBURN LIQUID LEVEL ELECTRODES

### WCC Series:

Metal parts are 303 or 304 non-magnetic stainless steel. Incorporates an internal conductive glass seal (not recommended for use above 450 volts). Non-steam applications up to 2,500 PSI at 120° F or 0 PSI at 700° F. Steam applications up to 250 PSI at 406° F

### WCC-KH Series:

Metal parts are 303 or 304 non-magnetic stainless steel. Incorporates a special insulator tip seal and Kovar center wire-glass seal. Non-steam applications up to 2,500 PSI at 120° F or 0 PSI at 450° F. Steam applications up to 450 PSI at 459° F

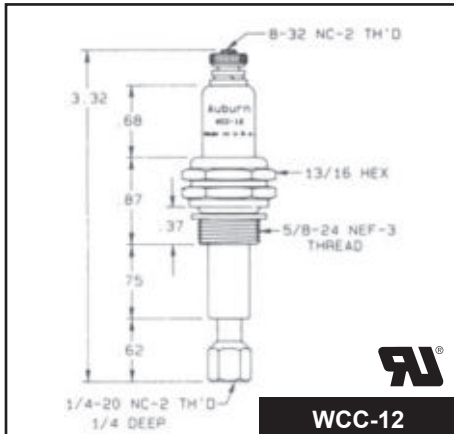

**WCC-12**

No.	Ref. No.
E5-WCC-12	WCC-12

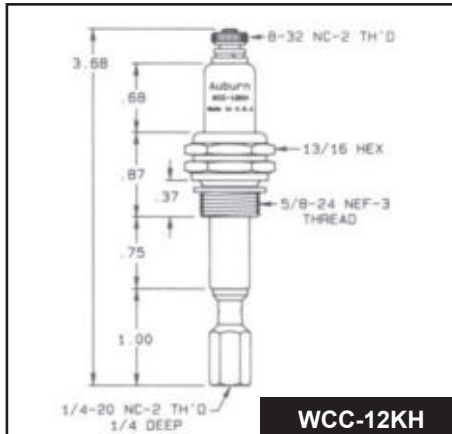

**WCC-12KH**

No.	Ref. No.
E5-WCC-12KH	WCC-12KH

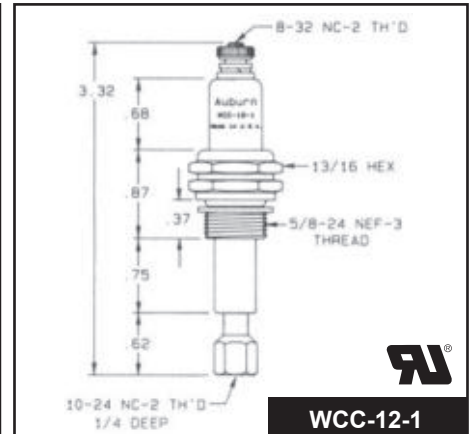

**WCC-12-1**

No.	Ref. No.
E5-WCC-12-1	WCC-12-1

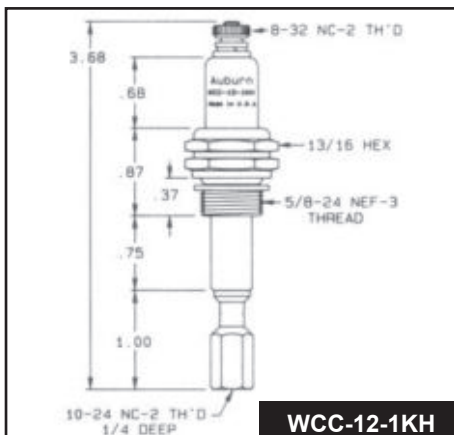

**WCC-12-1KH**

No.	Ref. No.
E5-WCC-12-1KH	WCC-12-1KH

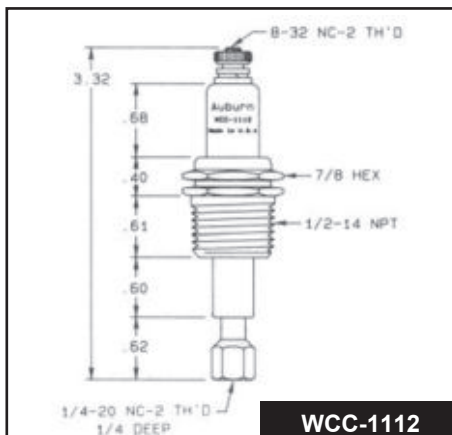

**WCC-1112**

No.	Ref. No.
E5-WCC-1112	WCC-1112

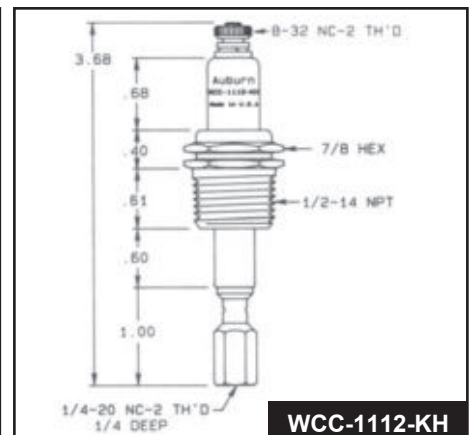

**WCC-1112-KH**

No.	Ref. No.
E5-WCC-1112-KH	WCC-1112-KH

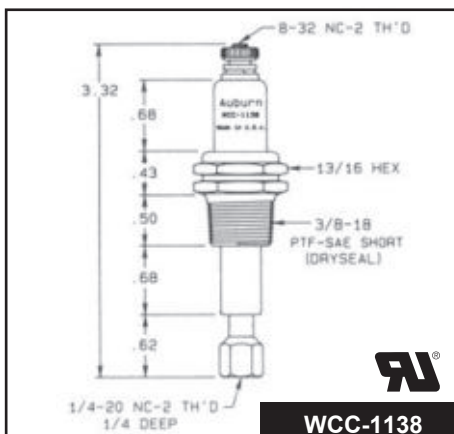

**WCC-1138**

No.	Ref. No.
E5-WCC-1138	WCC-1138

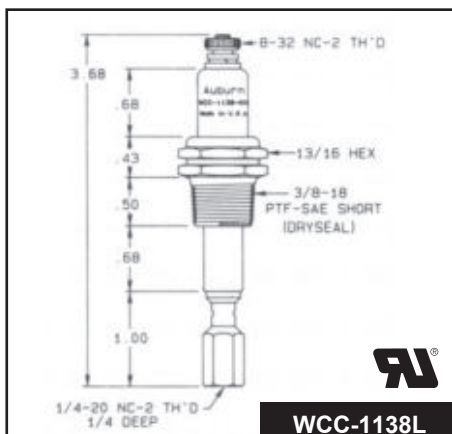

**WCC-1138L**

No.	Ref. No.
E5-WCC-1138L	WCC-1138L

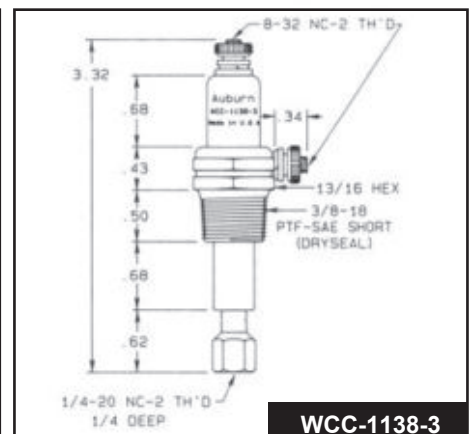

**WCC-1138-3**

No.	Ref. No.
E5-WCC-1138-3	WCC-1138-3



## AUBURN LIQUID LEVEL ELECTRODES

### WCT Series:

Metal parts are 303 or 304 non-magnetic stainless steel, center electrodes are one piece.

Non-steam applications up to 1,000 PSI at 120° F or 0 PSI at 400° F

Steam applications up to 100 PSI at 337° F

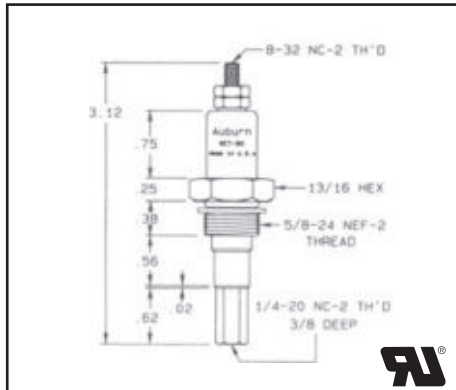

**WCT-90**

No.	Ref. No.
E5-WCT-90	WCT-90

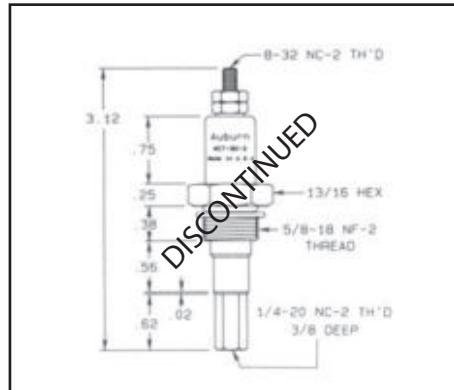

**WCT-90-2**

No.	Ref. No.
E5-WCT-90-2	WCT-90-2

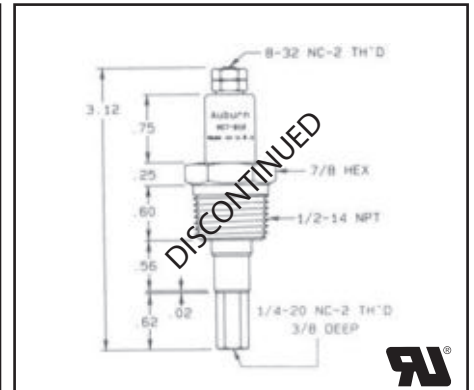

**WCT-912**

No.	Ref. No.
E5-WCT-912	WCT-912

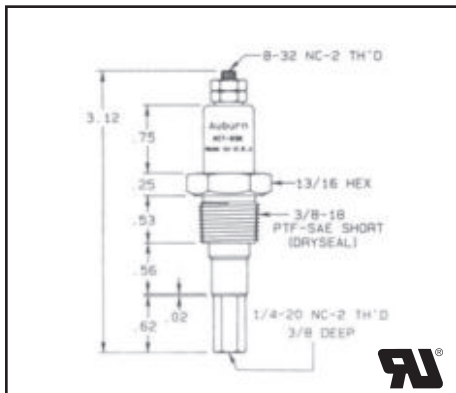

**WCT-938**

No.	Ref. No.
E5-WCT-938	WCT-938

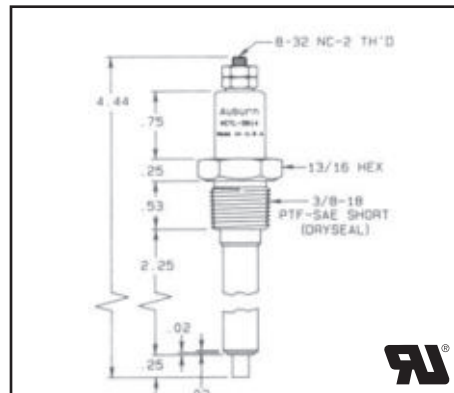

**WCTL-3814**

No.	Ref. No.
E5-WCTL-3814	WCTL-3814

As a major distributor of Auburn Liquid Level Electrodes, Westwood can special order any Auburn item not shown in this catalog and get it to you fast!





LIQUID LEVEL PROBES for FULTON BOILERS on page H9

Please order by No.

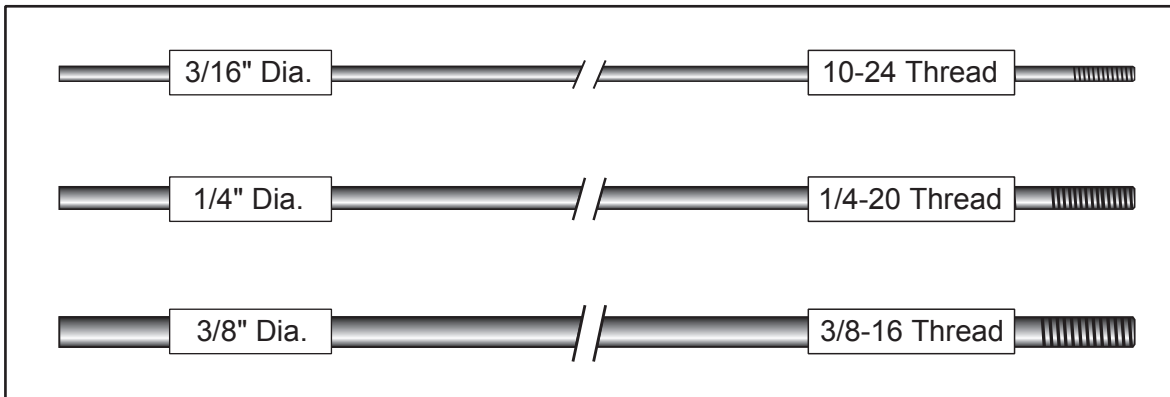

Westwood

**SOLID STAINLESS STEEL PROBES****FOR USE ON LIQUID LEVEL ELECTRODE ASSEMBLIES****STANDARD SIZES\***

 No.	Ref. No.	Thread	Length	Diameter
E5-1024-12	1024-12	10-24	12"	3/16"
E5-1024-18	1024-18	10-24	18"	3/16"
E5-1024-24	1024-24	10-24	24"	3/16"
E5-1420-6	1420-6	1/4-20	6"	1/4"
E5-1420-12	1420-12	1/4-20	12"	1/4"
E5-1420-18	1420-18	1/4-20	18"	1/4"
E5-1420-24	1420-24	1/4-20	24"	1/4"
E5-1420-36	1420-36	1/4-20	36"	1/4"
E5-3816-12	3816-12	3/8-16	12"	3/8"
E5-3816-18	3816-18	3/8-16	18"	3/8"
E5-3816-24	3816-24	3/8-16	24"	3/8"

\*Made to order non-standard lengths available by special order.



Take a look ...

LIQUID LEVEL PROBES for  
FULTON BOILERS on page H9

Westwood

CHAMPION

IGNITION ASSEMBLIES



*NOTE: Champion ignition assembly part numbers are now "E5-" followed by the former number.*

Example:

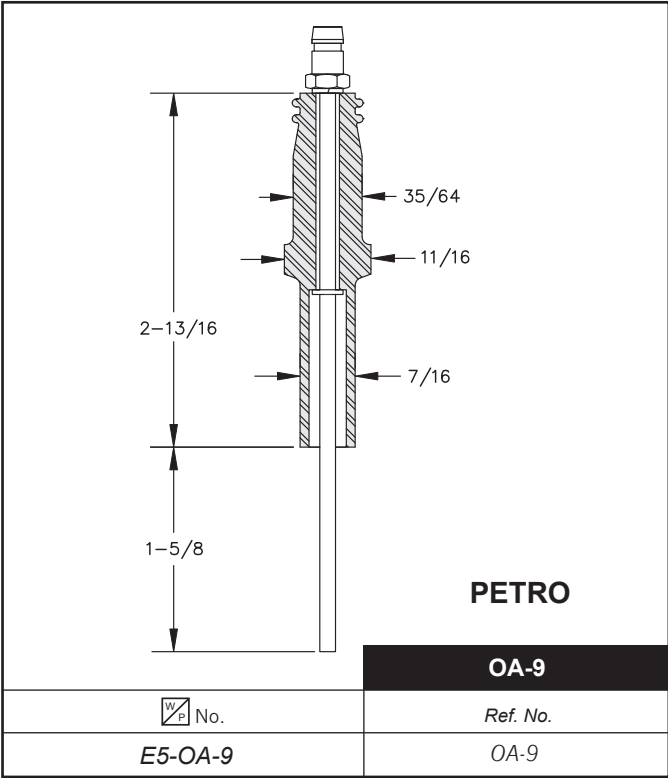
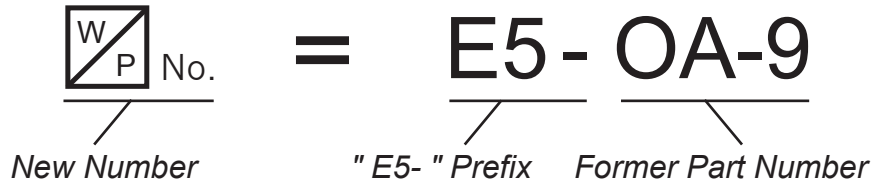

Westwood

**CHAMPION**

**IGNITION ASSEMBLIES**



14 MM

**A-25**

No.

Ref. No.

E5-A-25

A-25



14 MM

**CJ-8**

No.

Ref. No.

E5-CJ-8

CJ-8

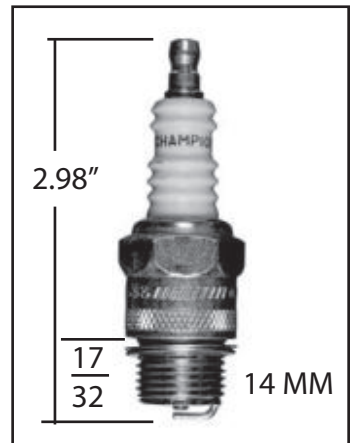

14 MM

**D-9**

No.

Ref. No.

E5-D-9

D-9



18 MM  
x 1.25MM

**D-89D**

No.

Ref. No.

E5-D-89D

D-89D



14 MM  
x 1.25MM

**H14Y**

No.

Ref. No.

E5-H14Y

H14Y

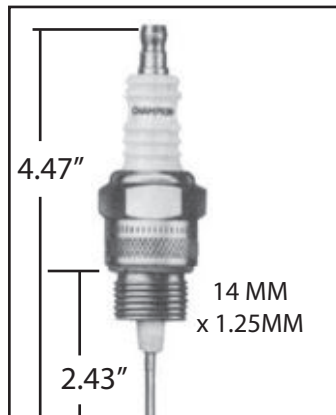

14 MM  
x 1.25MM

**J-99**

No.

Ref. No.

E5-J-99

J-99



18 MM  
x 1.25MM

**K97F**

No.

Ref. No.

E5-K97F

K97F

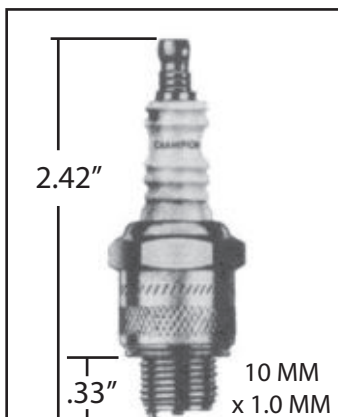

10 MM  
x 1.0MM

**UY-6**

No.

Ref. No.

E5-UY-6

UY-6



7/8-18  
THD

**W18**

No.

Ref. No.

E5-W18

W18

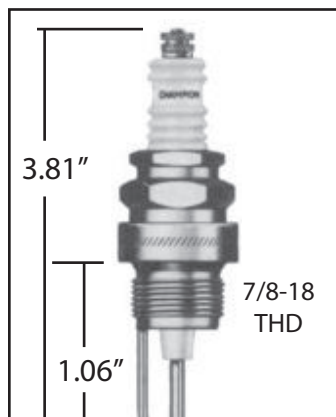

7/8-18  
THD

**W-95D**

No.

Ref. No.

E5-W-95D

W-95D

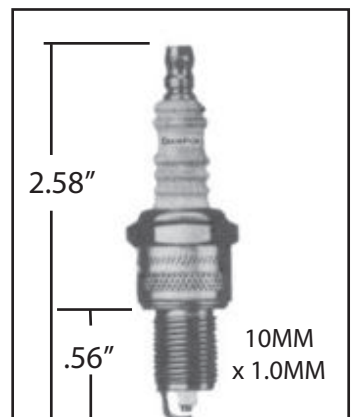

10MM  
x 1.0MM

**Z-6**

No.

Ref. No.

E5-Z-6

Z-6



# TERMINALS







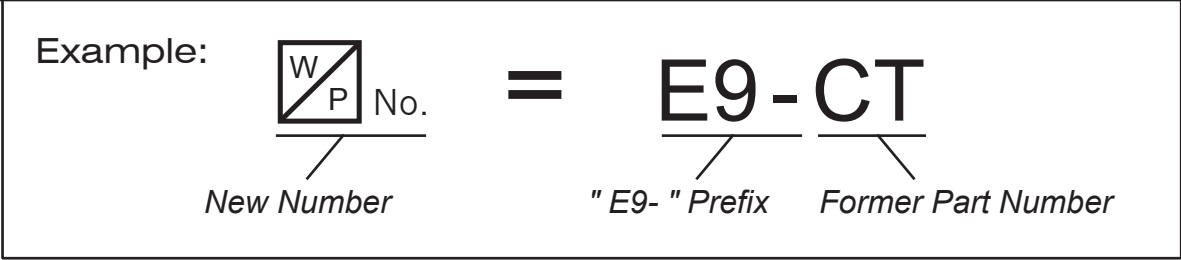













































## SPECIAL NOTE: NEW **Rajah™** TERMINAL PART NUMBERS

**Rajah™** terminals and related items part numbers are now "E9-" followed by the former part number.



Note: Terminal part number endings of 6-32, 8-32, 10-24, and 10-32 refer to terminal thread size

  No. E9-CT	  No. E9-SS	  No. E9-R-2	  No. E9-SF	  No. E9-TT
  No. E9-CT-TS 8-32 E9-CT-TS 10-32	  No. E9-SS-TS 10-32	  No. E9-SR	  No. E9-HS 6-32 E9-HS 10-32	  No. E9-CT-BS 6-32 E9-CT-BS 8-32 E9-CT-BS 10-32
  No. E9-SS-BS 6-32 E9-SS-BS 8-32 E9-SS-BS 10-32	  No. E9-HT 6-32 E9-HT 8-32 E9-HT 10-32	  No. E9-SX-1 6-32 E9-SX-1 10-32	  No. E9-CT-SS	  No. E9-ACT
  No. E9-ASS	  No. E9-CHT	  No. E9-BS 6-32 E9-BS 8-32 E9-BS 10-24 E9-BS 10-32	  No. E9-458-9 10-32	  No. E9-RAC
  No. E9-RASS	  No. E9-EBS 6-32 E9-EBS 10-32	  No. E9-457-6 6-32	  No. E9-SS-SOS	  No. E9-R-SOS

Please order by  No.



**TERMINALS**



Note: Terminal part number endings of 6-32, 8-32, 10-24, and 10-32 refer to terminal thread size















 No. E9-T-SOS	 No. E9-AS-SOS	 No. E9-BS-SOS	 No. E9-SSN	 No. E9-RSN
 No. E9-TSN	 No. E9-ASN	 No. E9-BSN	 No. E9-ACT-BS 6-32 E9-ACT-BS 10-32	 No. E9-DS-1
 No. E9-FF-1	 No. E9-CC-1	 No. E9-SS-LBS	 No. E9-SS-LTS	 No. E9-XC
 No. E9-SA-1 6-32	 No. E9-ITN 8-32 E9-ITN 10-32	 No. E9-ITN-S 6-32 E9-ITN-S 8-32	 No. E9-TC-10	 No. E9-TS-10
 No. E9-R-1	 No. E9-RS-3 10-32	 No. E9-RX-4 6-32 E9-RX-4 8-32 E9-RX-4 10-32	 No. E9-RX-5 10-32	 No. E9-RP-6
 No. E9-RC-5	 No. E9-RE-7	 No. E9-AEBF	 No. E9-EBF	 No. E9-B-10 10-32 5/16" Long
 No. E9-B-11 10-32 11/16" Long	 No. E9-BC-11	 No. E9-BS-12		







**TERMINALS**

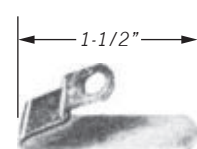
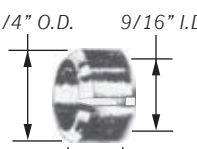
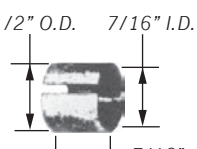
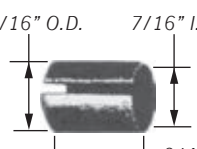
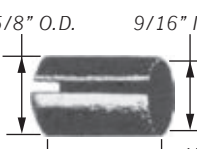

Note: Terminal part number endings of 6-32, 8-32, 10-24, and 10-32 refer to terminal thread size

<p><i>Reckett</i> <b>DISCONTINUED</b> USE E9-Y5-10</p>  <p><input checked="" type="checkbox"/> No. E9-S-15 10-32</p>	 <p><input checked="" type="checkbox"/> No. E9-AL-10</p>	 <p><input checked="" type="checkbox"/> No. E9-AS-10</p>	 <p><input checked="" type="checkbox"/> No. E9-ASC</p>	 <p><input checked="" type="checkbox"/> No. E9-S-10</p>
 <p><input checked="" type="checkbox"/> No. E9-CS</p>	 <p><input checked="" type="checkbox"/> No. E9-YL-10</p>	 <p><input checked="" type="checkbox"/> No. E9-YS-10</p>	 <p><input checked="" type="checkbox"/> No. E9-YSC</p>	<p>1-1/8" Long</p>  <p><input checked="" type="checkbox"/> No. E9-SCS-2 6-32</p>
<p>1-1/4" Long</p>  <p><input checked="" type="checkbox"/> No. E9-SCS-1 10-32</p>	 <p><input checked="" type="checkbox"/> No. E9-KBN 6-32 E9-KBN 10-24</p>	 <p><input checked="" type="checkbox"/> No. E9-DT</p>	 <p><i>Cleaver Brooks Spring</i> Connects plate assembly to ignitors - 20" Long</p> <p><input checked="" type="checkbox"/> No. E9-CBS</p>	

**SPECIALTY TERMINAL & ELECTRODE HARDWARE**

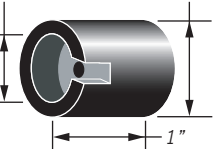
 <p>1-1/2"</p> <p>Walter Kidde brass buss bar</p> <p><input checked="" type="checkbox"/> No. E9-686 BAR</p>	<p>3/4" O.D. 9/16" I.D.</p>  <p>7/16"</p> <p>Beveled and split brass bushing</p> <p><input checked="" type="checkbox"/> No. E9-BB</p>	<p>1/2" O.D. 7/16" I.D.</p>  <p>7/16"</p> <p>Zinc plated split steel bushing</p> <p><input checked="" type="checkbox"/> No. E9-PB</p>	<p>9/16" O.D. 7/16" I.D.</p>  <p>3/4"</p> <p>Zinc plated split steel bushing</p> <p><input checked="" type="checkbox"/> No. E9-AB</p>	<p>5/8" O.D. 9/16" I.D.</p>  <p>1"</p> <p>Zinc plated split steel bushing</p> <p><input checked="" type="checkbox"/> No. E9-DB</p>
<p>3/4" O.D. - 9/16" I.D. 1/16" Thick</p>  <p>Cleaver Brooks split ring zinc plated steel</p> <p><input checked="" type="checkbox"/> No. E9-CBR</p>	<p>3/4" O.D. - 9/16" I.D. 1/16" Thick</p>  <p>Copper gasket - dished</p> <p><input checked="" type="checkbox"/> No. E9-467 GASKET</p>	<p>3/4" O.D. - 9/16" I.D. 1/32" Thick</p>  <p>Copper gasket - flat</p> <p><input checked="" type="checkbox"/> No. E9-I-18 GASKET</p>	<p>19/32" I.D. 3/4" O.D.</p>  <p>1"</p> <p>Black bakelite shield for Ray</p> <p><input checked="" type="checkbox"/> No. E9-500 SHIELD</p>	

**BUSS BARS**

<input checked="" type="checkbox"/> No.	Ref. No.	12" Length*
E9-TYPE ET	Type ET	Round brass with eyelet and 6-32 thread
E9-TYPE F	Type F	Flat brass with 1/8" hole
E9-TYPE ST	Type ST	Round brass with 6-32 thread

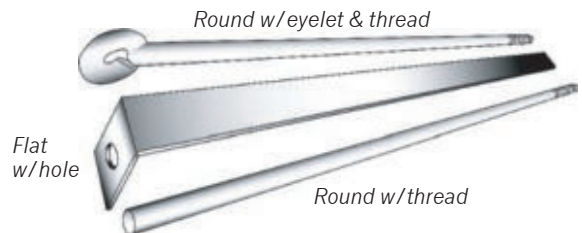

\* Other lengths available up to 24"

Please order by  No.





**IGNITION TERMINAL KITS**

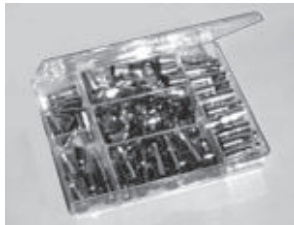

 No.	Ref. No.	Description
E9-34	34	<b>Rajah™ "Mini" Ignition Terminal Kit:</b>
		20 - CT Cage Terminals 12 - SS Spring Snap Terminals 20 - R2 Ring Terminals 10 - RAC Right Angle Cage Terminals 12 - SF Stud Ferrule Terminals
E9-54	54	<b>Rajah™ Transformer Terminal Kit:</b>
		6 - AS-10 Short Adapter Spring 6 - AL-10 Long Adapter Spring 2 - STS-10 Thumb Nut on Cage 2 - 458-9 Spring Plunger (10-32) 4 - B-10 Button Contact (short) 2 - B-11 Button Contact (long) 6 - CC-1 Cage on Cage 6 - RC-5 Ram's Horn on Cage 4 - RX4 Ram's Horn on Hex 2 - R1 Ram's Horn Clip 6 - HS Hollow Stud (10-32) 6 - SX Hex Stud (10-32)
E9-2097	2097	<b>Rajah™ "Pro" Ignition Terminal Kit:</b>
		24 - CT Cage Terminals 24 - SS Spring Snap Terminals 24 - R2 Ring Terminals 24 - SF Stud Ferrule Terminals 24 - RAC Right Angle Cage Terminals 100 - DT Distributor Terminals 24 - FF-1 Ferrule on Ferrule 1 - T200-10 (former #695) <b>Terminal Crimping Tool</b>
E9-3500	3500	<b>Rajah™ "Deluxe" Ignition Terminal Kit:</b>
		12 - CT Cage Terminals 12 - SS Spring Snap Terminals 12 - R2 Ring Terminals 12 - ACT Angle Cage Terminals 12 - SF Stud Ferrule Terminals 12 - BS Base Stud (6-32) 12 - BS Base Stud (10-32) 12 - HS Hollow Stud (6-32) 12 - HS Hollow Stud (10-32) 12 - CC-1 Cage on Cage 12 - CT-TS Cage on Stud (10-32) 12 - RC-5 Ram's Horn on Cage 12 - R-1 Ram's Horn Clip 12 - #299 Special GE Slotted Stud 12 - SX Hex Stud (10-32) 1 - 1/4" Nut Driver 1 - 5/16" Nut Driver 1 - T200-10 (former #695) <b>Terminal Crimping Tool</b>
E9-CK-1	CK-1	<b>Rajah™ Carlin Transformer Contact Kit:</b>
		For in the field conversion on Carlin Burner models 98, 99, 100, 101, 102 Webster transformer model 313-28AB85 2 - Contact clips 2 - Flat washers (#10) 2 - Shakeproof washers (#10) 2 - 10-32 nuts

**ELECTRICAL CLIPS & RUBBER BOOTS**





 <p><input checked="" type="checkbox"/> No. E9-LV CLIP</p>	<p>Vinyl</p>  <p><input checked="" type="checkbox"/> No. E9-LV BOOT</p>	 <p><input checked="" type="checkbox"/> No. E9-20 AMP CLIP</p>	<p>Vinyl</p>  <p><input checked="" type="checkbox"/> No. E9-20 AMP BOOT</p>
<p>Distributor nipple</p>  <p><input checked="" type="checkbox"/> No. E9-DN</p>	<p>Silicone Rubber</p>  <p><input checked="" type="checkbox"/> No. E9-250 BOOT</p>	<p>Silicone Rubber</p>  <p><input checked="" type="checkbox"/> No. E9-251 BOOT</p>	

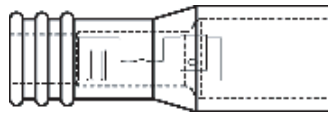

Take a look ...

JUMPERS & CORD CLIP SETS on page T13

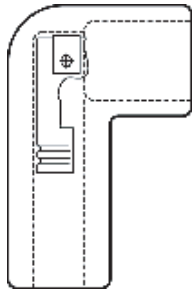
**HIGH TEMPERATURE CERAMIC SPARK PLUG BOOTS with Stainless Steel Terminals**

<input checked="" type="checkbox"/> No.	Ref. No.	Description
<b>E9-ECF</b>	ECF	EXTENDED CERAMIC BOOT - with stainless steel terminal for 7mm ignition wire  
<b>E9-AECF</b>	AECF	ANGLE EXTENDED CERAMIC BOOT - with stainless steel terminal for 7mm ignition wire  

Westwood

**IGNITION CABLE**

Cable Type	UL LISTED	W/P No.		
		25' Roll	100' Roll	1,000' Roll
GTO-15	Yes	E60-25	E60-100	E60-1000
White Silicone	-	E62-25	E62-100	-
Red Silicone	Yes	E63-25	E63-100	E63-1000

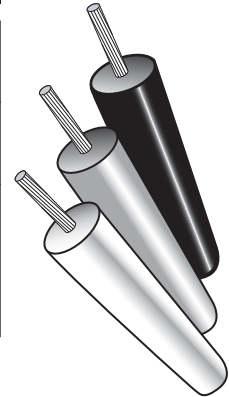

<b>GTO-15 (black)</b>	Large .275" outside diameter fits Rajah terminals perfectly. Withstands more than <b>15,000 VAC</b> with low current leakage. Resists arc-over, tracking, and burning. Tested to withstand conditions of heat, oil, and moisture. No. 14 gauge, 19 x 26 stranded tinned copper wire. All vinyl insulation affords low temperature flexibility. Flame retardant, will not support combustion. Tough and abrasion resistant, yet easy stripping. Temperature range: <b>UL LISTED</b> to 105 <sup>0</sup> C (221 <sup>0</sup> F)
<b>White Silicone</b>	Large .275" outside diameter fits Rajah terminals perfectly. Withstands more than <b>10,000 VAC</b> and <b>25,000 VDC</b> with low current leakage. No. 16 gauge, 19 x 26 stranded tinned copper wire. Natural Silicone insulation, high dielectric strength. Temperature range: -65 <sup>0</sup> F to 400 <sup>0</sup> F (-54 <sup>0</sup> C to 204 <sup>0</sup> C)
<b>Red Silicone</b>	Large .275" outside diameter fits Rajah terminals perfectly. Withstands more than <b>10,000 VAC</b> and <b>25,000 VDC</b> with low current leakage. No. 16 gauge, 19 x 26 stranded nickel plated copper wire. Natural Silicone insulation, high dielectric strength. Temperature range: -65 <sup>0</sup> F to 482 <sup>0</sup> F (-54 <sup>0</sup> C to 250 <sup>0</sup> C) <b>UL LISTED</b>

**CABLE ASSEMBLIES and FIBERGLAS BRAID**

W/P No.	Ref. No.	Description
E64	#3250	Red Silicone wire <b>high temperature</b> cable assembly with protective <b>metal braid</b> . Temperature range -65 <sup>0</sup> F to 450 <sup>0</sup> F. Overall length is 32-1/2".
E64-5	#RS-3350	Red Silicone wire <b>high temperature</b> cable assembly with red Silicone <b>boots</b> . Temperature range -65 <sup>0</sup> F to 450 <sup>0</sup> F. Withstands <b>10,000 VAC / 25,000 VDC</b> . Overall length is 33-1/2".
E64-20	#3253	Fiberglass braided sleeving. Fits over ignition cable for high temperature protection. Sold by the foot. (Ordering example: For 5' of sleeving order 5 of E64-20. Shipped as one piece)

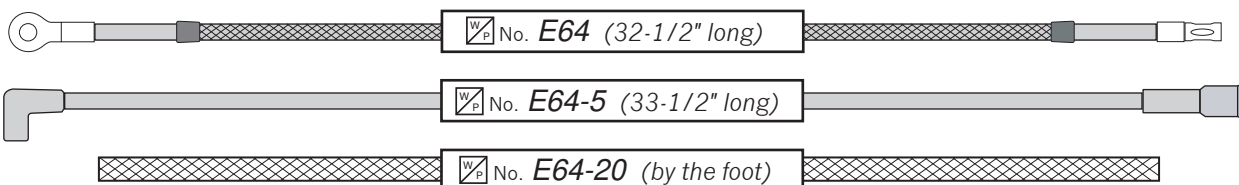

**ELECTRICAL ACCESSORIES**



**SOLDERLESS TERMINAL KIT**

No. **E70**

Contains 175 of the most popular terminals and connectors

**KIT REFILL TERMINALS - Part numbers are for a package of the quantity indicated**

 AWG: 22-16 Female .250 Tab No. E70-10	 AWG: 22-16 Ring #6 Stud No. E70-20	 AWG: 16-14 Ring #8 Stud No. E70-21	 AWG: 16-14 Spade #8 Stud No. E70-34	 AWG: 16-14 Spade #10 Stud No. E70-36	 AWG: 22-16 Butt Connector No. E70-40
<b>BACK ROW - All Packages of 100</b>					
 AWG: 16-14 Female .250 Tab No. E70-12	 AWG: 22-16 Ring #10 Stud No. E70-22	 AWG: 16-14 Ring #10 Stud No. E70-23	 AWG: 16-14 Spade #6 Stud No. E70-30	 AWG: 22-16 Spade #6 Stud No. E70-32	 AWG: 16-14 Butt Connector No. E70-42
<b>MIDDLE ROW - Packages of 100</b>					<b>Pkg. of 50</b>
 AWG: 12-10 Female .250 Tab No. E70-14	 AWG: 12-10 Ring #10 Stud No. E70-24	 AWG: 12-10 Ring 1/4" Stud No. E70-25	 AWG: 12-10 Ring 5/16" Stud No. E70-26	 AWG: 12-10 Spade #10 Stud No. E70-38	 AWG: 12-10 Butt Connector No. E70-44
<b>FRONT ROW - All Packages of 50</b>					

**WIRE CONNECTORS - Part numbers are for a package of 100**

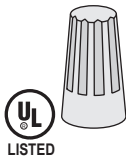

	<i>GREY</i>	<i>BLUE</i>	<i>ORANGE</i>	<i>YELLOW</i>	<i>RED</i>
No.	E70-50	E70-52	E70-54	E70-56	E70-58

**CABLE TIES - Part numbers are for a package of 100**

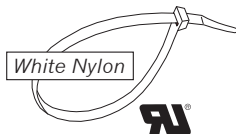

	4"	5-1/2"	7-1/2"	11"	14-1/2"
No.	E70-60	E70-62	E70-64	E70-66	E70-68

**ROUGH SERVICE BULBS**

Part numbers are for a box of 2 bulbs

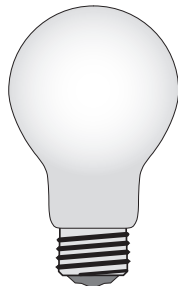

	75 Watt	100 Watt
No.	E70-75	E70-100



Please order by No.

**Westwood**  
**CAD CELL FLAME DETECTORS**

UNIVERSAL REPLACEMENT FOR HONEYWELL AND WHITE-RODGERS

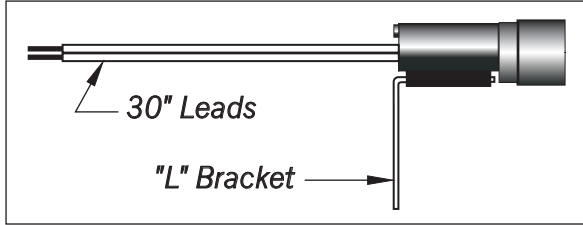

No. **E80**

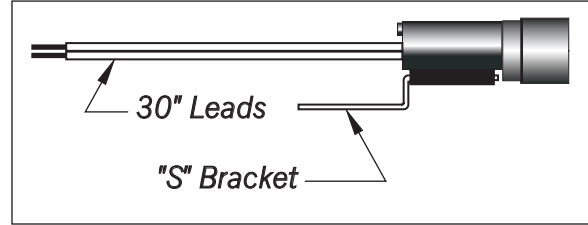

No. **E80-1**

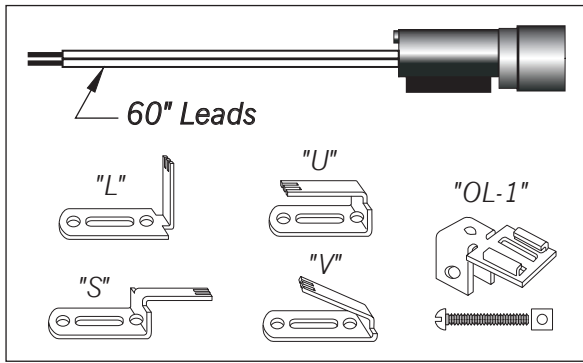

No. **E80-2**

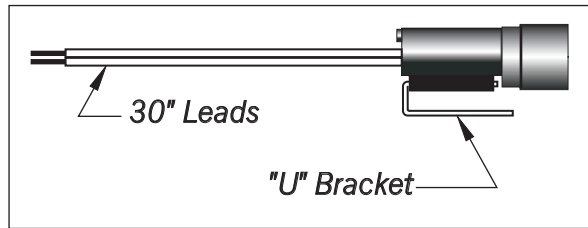

No. **E80-3**

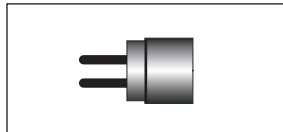

No. **E81**

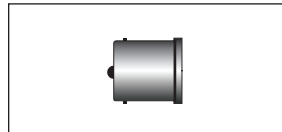

No. **E81-10**

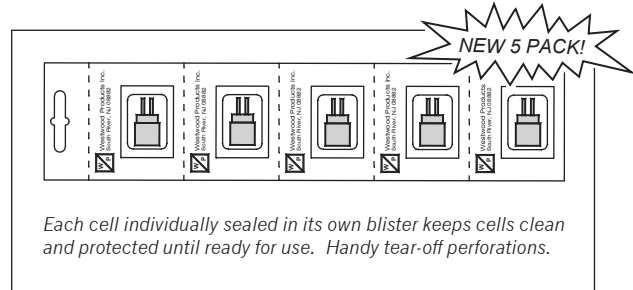

No. **E81-5**

No.	Ref. No.	Description
E80	TM-30L	Complete flame detector with cad cell eye*, 30" leads, "L" bracket, poly bag package
E80-1	TM-30S	Complete flame detector with cad cell eye*, 30" leads, "S" bracket, poly bag package
E80-2	TMK-60	Complete flame detector kit with cad cell eye*, 60" leads, "L" bracket, "S" bracket, "U" bracket, "V" bracket, "OL-1" special oil line bracket with mounting screw and nut, packaged in a box
E80-3	-	Complete flame detector with cad cell eye*, 30" leads, "U" bracket, poly bag package
E81	Type M	Cad cell eye* packaged in a box
E81-5	-	Cad cell eye* <b>5 pack</b> (blister card with 5 E81-5 eyes per card), tear-off perforations
E81-10	Type W	Cad cell eye, bayonet mount for White-Rodgers cad cell flame detector, packaged in a box

\* Cad cell eye replaces Honeywell 130367 and fits C554A flame detector



T70 Cad cell relay and eye tester on page T11

# THERMOSTAT GUARDS

METAL AND PLASTIC TAMPER PROOF DESIGNS IN PLEASING COLORS

*Designed for use in schools, industrial plants and military installations where rugged, maximum protection is the first consideration. The louvered covers cannot be twisted or jammed open. Bobby pins, pencils, letter openers and other such objects cannot be inserted through the cover to adjust the thermostat.*

- ▶ Metal guards are constructed of 18-22 gauge steel with a baked enamel finish
- ▶ Plastic guards are molded from hi-impact plastic and can be used with both horizontally or vertically mounted thermostats
- ▶ All guards come with eight tumbler lock, one key, and mounting hardware
- ▶ Guards with ring bases can be installed without removing the thermostat



No. **E140**



No. **E140-1**

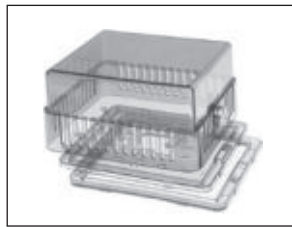

No. **E141**

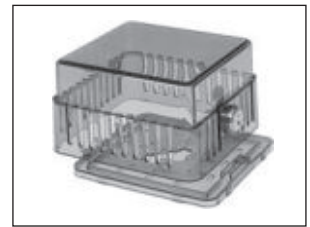

No. **E142**

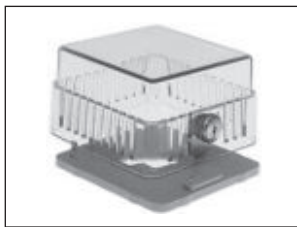

No. **E142-1**



No. **E142-2**



No. **E142-3**



No. **E143**

No.	Ref. No.	Inside Dimensions H" x W" x D"	Mat'l	Color	Base	Comments
<b>E140</b>	WTG-54VL	6-1/4 x 4-3/4 x 3	M	BE	SH	T80, T90, T91, T199, T330, T340, T42, T26, T87, T92, T651, T921, T872, T882
<b>E140-1</b>	WTG-54VLW	6 x 3-13/16 x 3-1/8	M	BE	RH	
<b>E141</b>	WTG-B	5-1/4 x 4-5/8 x 3-1/4	P	BR	SR	T199, TP970, TP971, TP972, TP973, T26, T87, TS86, T832, T853, TP910
<b>E142</b>	WTG-EB	3-7/8 x 3-1/2 x 2-1/2	P	BR	S	
<b>E142-1</b>	WTG-EK	3-7/8 x 3-1/2 x 2-1/2	P	CL	S	
<b>E142-2</b>	WTG-EM	3-7/8 x 3-1/2 x 2-1/2	M	BE	S	
<b>E142-3</b>	WTG-EO	3-7/8 x 3-1/2 x 2-1/2	P	OP	S	
<b>E143</b>	WTG-K	5-1/4 x 4-5/8 x 3-1/4	P	CL	SR	

M=Metal  
 P=Plastic  
 BE=Beige  
 BR=Bronze  
 CL=Clear  
 OP=Opaque  
 WH=White  
 H=Hinged  
 R=Ring  
 S=Solid

Please order by No.



# THERMOSTAT GUARDS (CONTINUED)

METAL AND PLASTIC TAMPER PROOF DESIGNS IN PLEASING COLORS

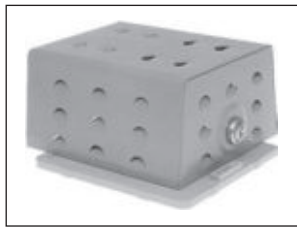

No. **E143-1**

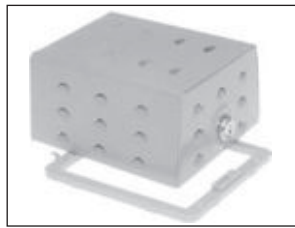

No. **E143-2**

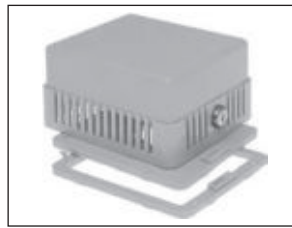

No. **E143-3**

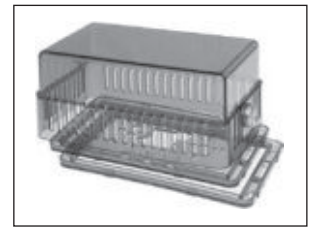

No. **E144**

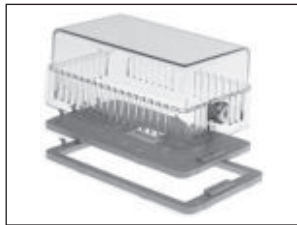

No. **E144-1**



No. **E144-2**



No. **E144-3**

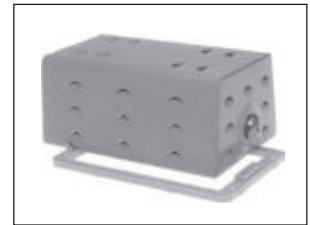

No. **E144-4**



No. **E145 Series**



No. **E146**

No.	Ref. No.	Inside Dimensions H" x W" x D"	Mat'l	Color	Base	Comments	
<b>E143-1</b>	WTG-KM	5-1/4 x 4-5/8 x 3	M	BE	S	T80, T90, T91, T99, T199, T330, T340, T42, TA42, T26, TS86, T87, T92, T498, T651, T834, T921, T872, T882	
<b>E143-2</b>	WTG-KWM	5-1/4 x 4-5/8 x 3-1/4	M	BE	R		
<b>E143-3</b>	WTG-O	5-1/4 x 4-5/8 x 3-1/4	P	OP	SR		
<b>E144</b>	WTG-RB	6-3/8 x 3-1/2 x 3-1/4	P	BR	SR		
<b>E144-1</b>	WTG-RK	6-3/8 x 3-1/2 x 3-1/4	P	CL	SR		
<b>E144-2</b>	WTG-RM	6-3/8 x 3-1/2 x 3	M	BE	S		
<b>E144-3</b>	WTG-RO	6-3/8 x 3-1/2 x 3-1/4	P	OP	SR		
<b>E144-4</b>	WTG-RWM	6-3/8 x 3-1/2 x 3-1/4	M	BE	R		
<b>E145</b>	WTG-UB2	8-1/8 x 4-5/8 x 3-5/8	P	BR	SR		General, White-Rodgers, Barber Colman, Honeywell, Robertshaw, Camstat, Penn
<b>E145-1</b>	WTG-UK2	8-1/8 x 4-5/8 x 3-5/8	P	CL	SR		
<b>E146</b>	WTG-UM	7-1/4 x 5-3/8 x 3-1/2	M	BE	S		

M=Metal  
 P=Plastic  
 BE=Beige  
 BR=Bronze  
 CL=Clear  
 OP=Opaque  
 WH=White  
 H=Hinged  
 R=Ring  
 S=Solid

# THERMOSTAT GUARDS (CONTINUED)

METAL AND PLASTIC TAMPER PROOF DESIGNS IN PLEASING COLORS



No. **E147 Series**



No. **E148**

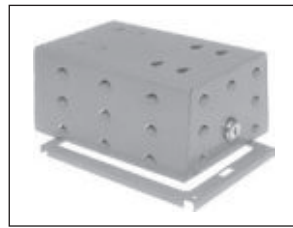

No. **E149**

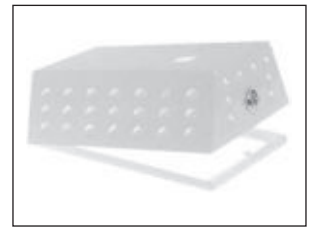

No. **E150 Series**



No. **E151**

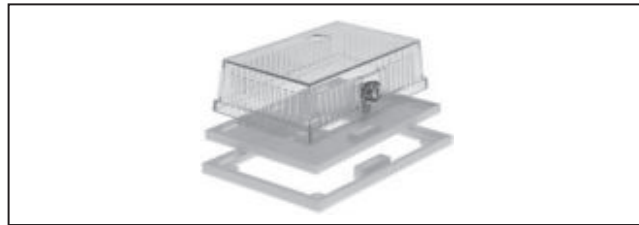

No. **E151-1, -2**



No. **E151-3**

No.	Ref. No.	Inside Dimensions H" x W" x D"	Mat'l	Color	Base	Comments
<b>E147</b>	WTG-UM1	9-3/8 x 6-3/4 x 3	M	WH	SH	Honeywell T7300 series
<b>E147-1</b>	WTG-UM1DH	9-3/8 x 6-3/4 x 3	M	WH	SH	Honeywell T7300 series w/display opening
<b>E147-2</b>	WTG-UM1DOH	9-3/8 x 6-3/4 x 3	M	WH	SH	Honeywell T7300 series w/override/display opening
<b>E147-3</b>	WTG-UM1DOWR	9-3/8 x 6-3/4 x 3	M	WH	SH	White-Rodgers IF90 series w/override/display opening
<b>E147-4</b>	WTG-UM1OH	9-3/8 x 6-3/4 x 3	M	WH	SH	Honeywell T7300 series w/override opening
<b>E147-5</b>	WTG-UM1SDH	9-3/8 x 6-3/4 x 3	M	WH	SH	Honeywell T7400 series w/display opening
<b>E148</b>	WTG-UO2	8-1/8 x 4-5/8 x 3-5/8	P	OP	SR	
<b>E149</b>	WTG-UWM	6-3/4 x 4-1/4 x 3-9/16	M	BE	R	
<b>E150</b>	WTG-UWM1	9-3/8 x 6-3/4 x 3	M	WH	RH	Honeywell T7300 series
<b>E150-1</b>	WTG-UWM1DH	9-3/8 x 6-3/4 x 3	M	WH	RH	Honeywell T7300 series w/display opening
<b>E150-2</b>	WTG-UWM1DOH	9-3/8 x 6-3/4 x 3	M	WH	RH	Honeywell T7300 series w/override/display opening
<b>E150-3</b>	WTG-UWM1DOWR	9-3/8 x 6-3/4 x 3	M	WH	RH	White-Rodgers IF90 series w/override/display opening
<b>E150-4</b>	WTG-UWM1OH	9-3/8 x 6-3/4 x 3	M	WH	RH	Honeywell T7300 series w/override opening
<b>E150-5</b>	WTG-UWM1SDH	9-3/8 x 6-3/4 x 3	M	WH	RH	Honeywell T7400 series w/display opening
<b>E151</b>	WTG-DB	4-1/8 x 7-1/16 x 2-1/4	P	BR	SR	
<b>E151-1</b>	WTG-DK	4-1/8 x 7-1/16 x 2-1/4	P	CL	SR	
<b>E151-2</b>	WTG-DK1	4-1/8 x 7-1/16 x 2-1/4	P	CL	SR	w/override opening
<b>E151-3</b>	WTG-DO	4-1/8 x 7-1/16 x 2-1/4	P	OP	SR	

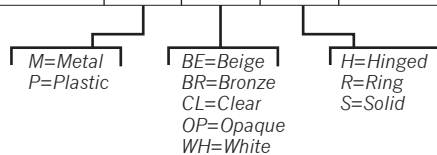

Please order by No.

## ULTRAGLO™ Thermostat Light

Mounts anywhere!

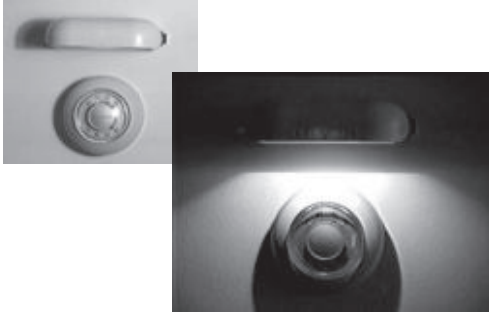

*This easy to mount battery powered light has an ultra bright bulb that draws little current. It can be mounted in any convenient location with the two mounting screws provided. Easily slips out of its mounting bracket for use as a hand light. Use in cars, boats, RVs and campers too!*

 No. **E140-40**

## REPLACEMENT ZONE VALVE MOTOR

For motor driven OPEN, spring return CLOSE valves  
(ie. Erie, Flare, Honeywell, Superior)

**INSTALLS WITHOUT REMOVING VALVE FROM PIPING  
USING EASY TO INSTALL EXTENDED BRASS SCREWS**

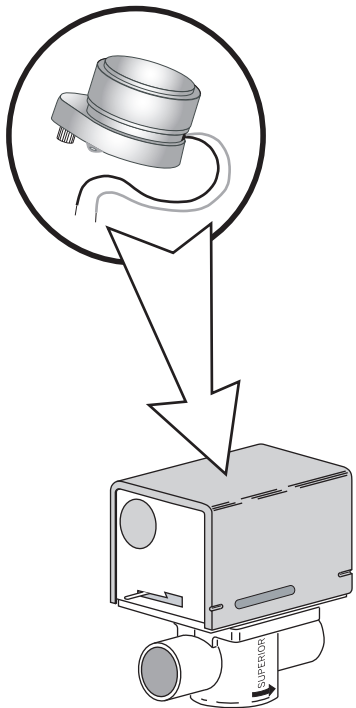

**New easy to install screws!**

 No.	Description
<b>E180</b>	Individually packaged with installation instructions, wire nuts, and easy to install extended brass mounting screws 24 VAC, 50/60 Hz, .32 A